

MAZ

**DOUBLE INLET CENTRIFUGAL FANS WITH AIRFOIL
BACKWARD CURVED BLADES WITH WELDED CASING**

**VENTILATORI CENTRIFUGHI A DOPPIA ASPIRAZIONE
CON PALE A PROFILO ALARE CON COCCLEA SALDATA**

MHZ

**DOUBLE INLET CENTRIFUGAL FANS WITH
BACKWARD CURVED BLADES WITH WELDED CASING**

**VENTILATORI CENTRIFUGHI A DOPPIA ASPIRAZIONE
A PALE ROVESCE CON COCCLEA SALDATA**

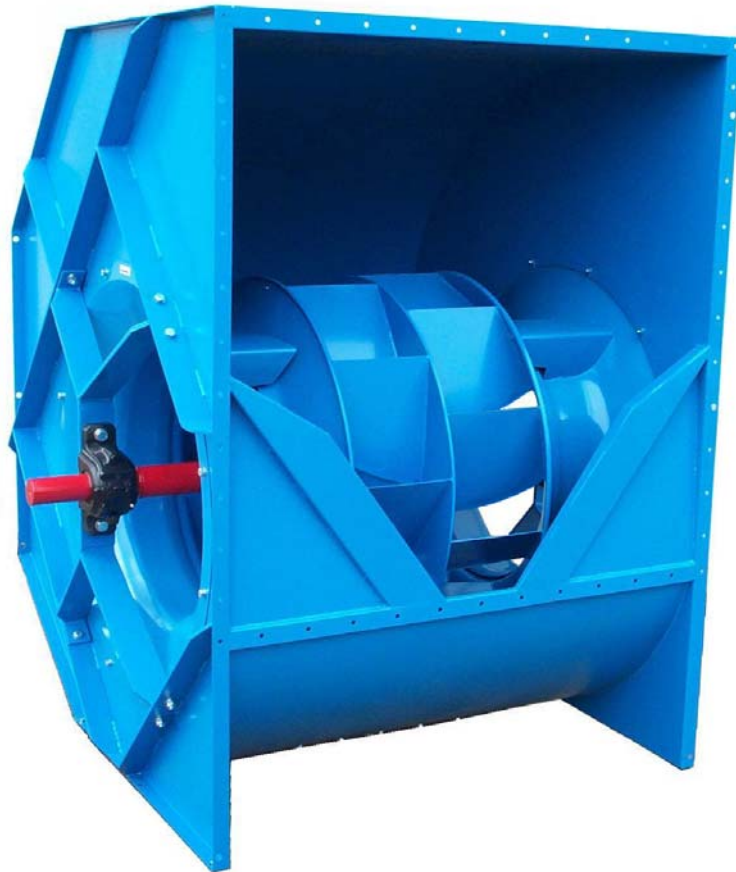

comefri

2^a Edition - subject to future integrations
2^a Ausgabe - Ergänzungen vorbehalten
2^a Edition - passible à futures intégrations
2^a Edizione - soggetta a future integrazioni



comefri

DOUBLE INLET CENTRIFUGAL FANS WITH AIRFOIL BACKWARD CURVED BLADES WITH WELDED CASING - MAZ
VENTILATORI CENTRIFUGHI A DOPPIA ASPIRAZIONE CON PALE A PROFILO ALARE CON COCLEA SALDATA - MAZ
DOUBLE INLET CENTRIFUGAL FANS WITH BACKWARD CURVED BLADES WITH WELDED CASING - MHZ
VENTILATORI CENTRIFUGHI A DOPPIA ASPIRAZIONE A PALE ROVESCE CON COCLEA SALDATA - MHZ

C-0013 February 2015



COMEFRI SpA factory at Magnano in Riviera (UD) – Italy with 14.500 m² workshop.
Production of radial fans for airconditioning and general ventilation.

Stabilimento COMEFRI SpA di Magnano in Riviera (UD) Italia, con 14.500 m² coperti.
Produzione di ventilatori centrifughi per il condizionamento e la ventilazione.



COMEFRI SpA factory at Artegn (UD) – Italy with 6.300 m² workshop. Production of industrial fans and special executions. Test facilities: laboratory accredited by AMCA.

Stabilimento COMEFRI SpA di Artegn (UD) Italia, con 6.300 m² coperti. Produzione di ventilatori industriali e speciali. Laboratorio Prove Aeruliche e Ricerca accreditato AMCA.

Contents

Indice

Page
Pagina

- 1. Standard MAZ / MHZ production range
- 2. Suond levels
- 3. MAZ Performance charts
- 4. MHZ Performance charts
- 5. Fan dimensions

- Caratteristiche generali della serie MAZ / MHZ
- Rumorosità
- Curve caratteristiche della serie MAZ
- Curve caratteristiche della serie MHZ
- Dimensioni dei ventilatori

- 1
- 3
- 9
- 22
- 35

1. Standard MAZ – MHZ production range

Comefri's MAZ and MHZ, double-inlet double-width centrifugal fans (fig.1) cover a size range from 315 to 1250, and are designed to meet specific requirements as:

- Increased strength
- Easier maintenance
- High-end performances with outstanding efficiency
- Low noise emissions

Typical applications fields for these fans are the naval industry, electronics sector and heavy duty HVAC, where they replace the so-called "Gesc" (fully welded housing) present versions of the NTHZ and TZAF FF, and for light industrial applications where reliability plays a vital role.

The MAZ and MHZ fans can be supplied in accordance with ATEX directive 94/9/CE: in this case the technical solutions adopted to comply with the requirements of the relevant standards imply a reduction in the fan performances, reduction that in accordance with standards ISO 13348 - DIN 24166 can be defined as a one-step increase of the tolerance class originally defined for the standard construction, i.e. from tolerance Class 2 to tolerance Class 3. For more technical details and selections please contact Comefri sales office.

1. Caratteristiche generali delle serie MAZ – MHZ

I ventilatori centrifughi a doppia aspirazione della serie MAZ ed MHZ (fig.1) sono costruiti nelle grandezze dalla 315 alla 1250 e sono nati per rispondere a quelle esigenze applicative per cui è richiesta:

- maggior robustezza
- facilità di manutenzione
- alte prestazioni con elevato rendimento aeraulico e basse emissioni acustiche.

I settori a cui questi nuovi modelli di ventilatori centrifughi principalmente si rivolgono sono quello navale, dell'off-shore, dei semiconduttori, del condizionamento pesante, in sostituzione dell'attuale versione "Gesc" (versione con coclea saldata attualmente disponibile sia per i ventilatori a pala con profilo alare, TZAF FF, sia per i ventilatori centrifughi a pala rovescia, NTHZ) e nelle applicazioni tipiche dell'industriale leggero, dove la componente affidabilità gioca un ruolo primario. I ventilatori MAZ e MHZ possono essere forniti in esecuzione ATEX in accordo alla direttiva 94/9/CE; In questo caso le specifiche costruttive adottate, in conformità alle norme di riferimento, comportano una riduzione delle prestazioni del ventilatore che, in relazione a quanto definito dalle norme ISO 13348 - DIN24166, è valutabile e quantificabile nell' aumento di una "Classe di tolleranza" sulle prestazioni fornite, rispetto a quelle previste per lo stesso ventilatore in esecuzione standard (da Classe 2 a Classe 3). Nello specifico, per la selezione ed i dettagli tecnici e/o informazioni commerciali, contattare Comefri.



Fig.1



comefri

DOUBLE INLET CENTRIFUGAL FANS WITH AIRFOIL BACKWARD CURVED BLADES WITH WELDED CASING - MAZ
VENTILATORI CENTRIFUGHI A DOPPIA ASPIRAZIONE CON PALE A PROFILO ALARE CON COCLEA SALDATA - MAZ
DOUBLE INLET CENTRIFUGAL FANS WITH BACKWARD CURVED BLADES WITH WELDED CASING - MHZ
VENTILATORI CENTRIFUGHI A DOPPIA ASPIRAZIONE A PALE ROVESCE CON COCLEA SALDATA - MHZ

C-0013 February 2015

The centrifugal fans MAZ (equipped with airfoil blades impeller -fig.2), and the MHZ (with backward curved blades impeller - fig.3) can be considered a variant of the present series TZAF FF and NTHZ , equipped with a fully welded, reinforced housing.



Fig.2



Fig.3

I ventilatori centrifughi COMEFRI a doppia aspirazione MAZ (con girante a profilo alare (fig.2)) ed MHZ (con girante a profilo curvo rovescio (fig.3)) sono una evoluzione delle rispettive serie attuali TZAF FF ed NTHZ ottenuta mediante l'utilizzo di una coclea interamente saldata.

The housing structure is made by black steel sheets, reinforced with steel stiffeners, completely welded and painted with corrosion-proof epoxy paint.

Bearing support is designed as a separate component, and can be fixed in four different positions to optimize belt installation. It can be easily removed, as the inlet cone, for an easy access to the impeller, leaving the housing in place. The optimal working area is within 90 and 100% of the maximum rpms, with a consequent reduction of the fan vibration levels.

Three different sub-versions are available as standard, T1, T2L and T2. On request, special executions are possible, when increased performances are requested. Stainless steel and hot dip galvanized versions are also available.

La struttura della coclea è in lamiera nera d'acciaio rinforzata da profilati saldati, e dotata di un sistema per il supporto dei cuscinetti che può essere orientato in base alla azione del tiro cinghia, e che consente un facile smontaggio laterale dell'insieme boccali, girante-albero-cuscinetti, lasciando la coclea in opera (fig4). L'impiego ottimale di questi ventilatori si ha nel loro utilizzo nel campo compreso tra il 90% ed il 100% dei giri massimi delle rispettive serie TZAF FF ed NTHZ con il conseguente ottenimento di un ridotto livello di vibrazione globale della macchina. I ventilatori vengono realizzati nelle esecuzioni standard versione T1, T2L e T2. Su richiesta sono disponibili esecuzioni speciali quando si vogliono prestazioni al di sopra degli attuali massimi di catalogo. Sono disponibili anche versioni in acciaio inossidabile o con trattamento di galvanizzazione a caldo.

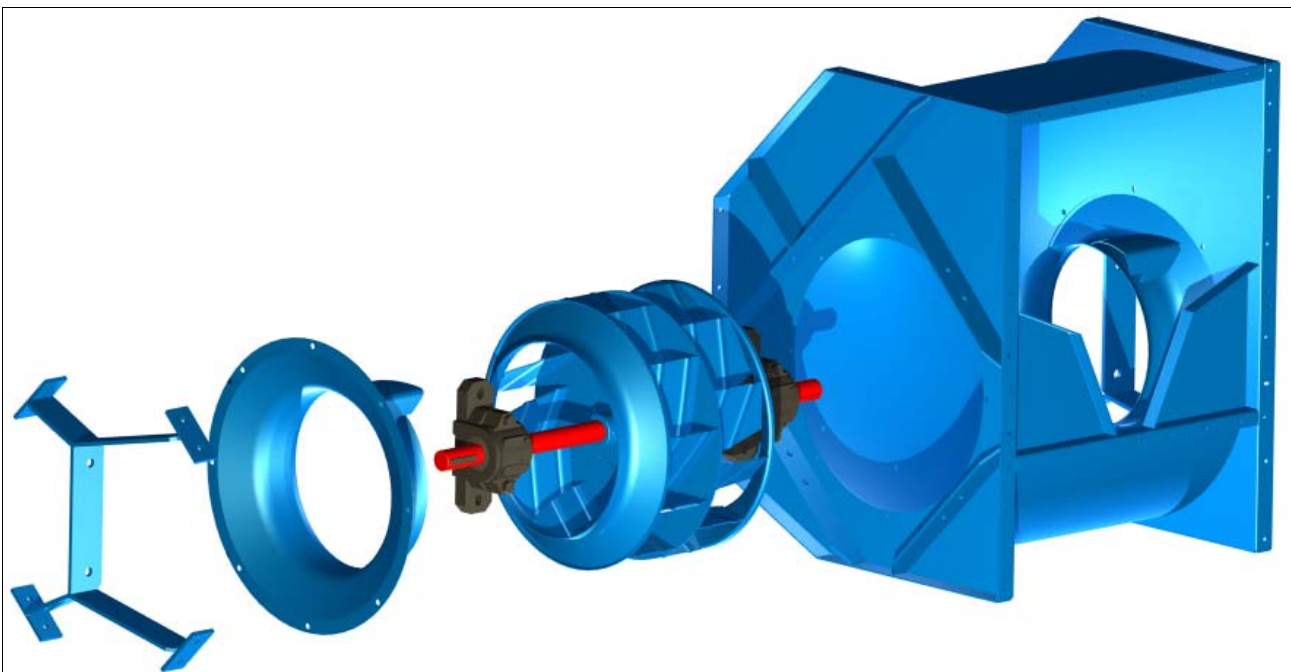

Fig.4

2. Sound levels

The measurements of noise levels are taken according to ISO, DIN, AMCA and BS Standards using a real-time frequency analyser. The sound power level L_{WA} , referred to $W_0=10^{-12}$ watt, required for calculation and design of sound absorbing units, is marked on the performance charts.

Sound data are determined according to DIN 45635-38, BS EN ISO 5136 at ANSI-AMCA 330 – In-duct method. The accuracy class, as defined by DIN 24166, Class 2, i.e. the permissible deviation on the read value is equal to +4 dBA

Symbols and Formulae:

L_{wA4}	A-weighted Total Sound Power Level inside the outlet duct	[dBA]
L_{wA7}	A-weighted Total Sound Power Level at the fan inlet, with ducted outlet	[dBA]
L_{w4}	Total Sound Power Level inside the outlet duct	[dB]
L_{woc14}	Sound Power Level inside the outlet duct at a specific Octave Band	[dB]
$L_{woc14A4}$	A-weighted Sound Power Level inside the outlet duct at a specific Octave Band	[dBA]
f_m	Octave Band Mid-Frequency	[Hz]
ΔL_{woc14}	Difference between Sound Power Level inside the outlet duct at a specific Octave Band, L_{woc14} and A-weighted Total Sound Power Level inside the outlet duct, L_{wA4}	[dB]
ΔL_{w4}	Difference between the Total Sound Power Level inside the outlet duct, L_{w4} and the A-weighted Total Sound Power Level inside the outlet duct, L_{wA4}	[dB]
L_{w6}	Total Sound Power Level at the free outlet	[dB]
ΔL_{wcorr}	Free outlet factor	[dB]
$L_{woc14A6}$	A-weighted Sound Power Level at a specific Octave Band at the free outlet	[dBA]

Sound measurement test rig scheme according to

DIN 45635-38 / BS EN ISO 5136 / ANSI-AMCA330

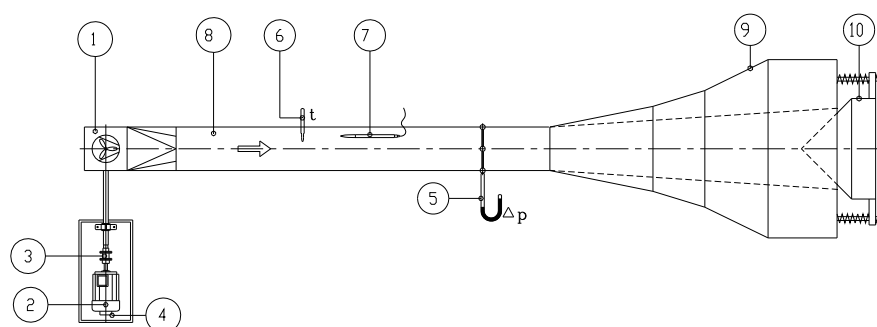

1. Fan / Ventilatore
2. Electric motor drive / Motore elettrico
3. Torquemeter / Torsiometro
4. Tachometer / Contagiri
5. Differential pressure gauge / Manometro differenziale
6. Temperature probe / Sonda termometrica
7. Microphone with turbulence screen / Microfono con schermo antiturbolenza
8. Test duct / Canale di prova
9. Anechoic termination / Terminale anecoico
10. Adjustable anechoic end / Chiusura anecoica regolabile

2.0.1. Sound Power Level at fan inlet

The Sound Power Level at the fan inlet, is available in our AEOLUS selection program.

2. Rumorosità

La misura della rumorosità è stata eseguita secondo le norme ISO, DIN, BS, UNI ed ANSI-AMCA, per mezzo di un analizzatore di frequenza in tempo reale. Sulle curve caratteristiche è riportato il Livello di Potenza Sonora riferito a $W_0 = 10^{-12}$ watt, necessario per il calcolo nelle varie applicazioni e per il dimensionamento di eventuali silenziatori.

I Livelli di Potenza Sonora sono stati determinati secondo le norme DIN 45635-38, BS EN ISO 5136 e ANSI-AMCA 330 metodo in canale; la classe di precisione, come definita dalle norme DIN 24 166, per quanto riguarda i valori di rumorosità riportati sui cataloghi, è Classe 2, con una tolleranza sui valori indicati di +4 dBA.

Simboli e formule:

L_{wA4}	Livello di Potenza Sonora Totale nel canale di mandata, ponderato in scala A	[dBA]
L_{wA7}	Livello di Potenza Sonora Totale all'aspirazione con mandata canalizzata, ponderato in scala A	[dBA]
L_{w4}	Livello di Potenza Sonora Totale nel canale di mandata ...	[dB]
L_{woc14}	Livello di Potenza Sonora nel canale di mandata in Banda d'Ottava	[dB]
$L_{woc14A4}$	Livello di Potenza Sonora nel canale di mandata in Banda d'Ottava, ponderato in scala A	[dBA]
f_m	Frequenza centrale di Banda d'Ottava	[Hz]
ΔL_{woc14}	Differenza tra il Livello di Potenza Sonora nel canale di mandata in Banda d'Ottava, L_{woc14} ed il Livello di Potenza Sonora Totale nel canale di mandata ponderato in scala A, L_{wA4}	[dB]
ΔL_{w4}	Differenza tra il Livello di Potenza Sonora Totale nel canale di mandata, L_{w4} ed il Livello di Potenza Sonora Totale nel canale di mandata ponderato in scala A, L_{wA4}	[dB]
L_{w6}	Livello di Potenza Sonora Totale con bocca di mandata libera	[dB]
ΔL_{wcorr}	Fattore di correzione per bocca di mandata libera ...	[dB]
$L_{woc14A6}$	Livello di potenza sonora con bocca di mandata libera in Banda d'Ottava, ponderato in scala A	[dBA]

Schema banco prova rumore secondo norme

2.0.1. Livelli di potenza sonora all'aspirazione

I Livelli di Potenza Sonora alla aspirazione, sono disponibili sul nostro programma di selezione AEOLUS.



DOUBLE INLET CENTRIFUGAL FANS WITH AIRFOIL BACKWARD CURVED BLADES WITH WELDED CASING - MAZ
 VENTILATORI CENTRIFUGHI A DOPPIA ASPIRAZIONE CON PALE A PROFILO ALARE CON COCLEA SALDATA - MAZ
 DOUBLE INLET CENTRIFUGAL FANS WITH BACKWARD CURVED BLADES WITH WELDED CASING - MHZ
 VENTILATORI CENTRIFUGHI A DOPPIA ASPIRAZIONE A PALE ROVESCE CON COCLEA SALDATA - MHZ

C-0013 February 2015

2.1. The Sound Data of the fan are determined as follows:

1. The A-weighted Total Sound Power Level L_{wA4} inside the outlet duct can be read on the Performance Chart, for a given fan performance.
2. The Sound Power Level L_{woct4} , at a specific Octave Band Mid-Frequency, inside the outlet duct, can be determined from following formula:

$$L_{woct4} = L_{wA4} + \Delta L_{woct4}$$

3. The Total Sound Power Level inside the outlet duct can be obtained from the following formula:

$$L_{w4} = L_{wA4} + \Delta L_{w4}$$

The values for ΔL_{woct4} and ΔL_{w4} are given in the Sound Data Tables section 2.3..

2.1. I livelli sonori dei ventilatori si determinano nel modo seguente:

1. Si legge il valore L_{wA4} del Livello di Potenza Sonora ponderato in scala A, sui diagrammi in corrispondenza delle prestazioni richieste
2. Il Livello di Potenza Sonora in Bande d'Ottava L_{woct4} , all'interno del canale di mandata, può essere calcolato con la formula seguente:

3. Il Livello di Potenza Sonora Totale all'interno del canale di mandata può essere calcolato con la formula seguente:

I valori di ΔL_{woct4} e ΔL_{w4} sono riportati nelle tabelle del paragrafo 2.3..

2.2. Total Sound Power Level at the free outlet, L_{w6}

The Total Sound Power Level, outside the termination of the outlet duct, can be calculated with approximation using of the "End Reflection" concept : part of the sound power generated by the fan at the discharge is reflected back into the duct when there is an abrupt termination. The value L_{w6} , at the outlet in a free discharge condition, can be considered approximately equal to the: Total Sound Power Level outside the termination of the outlet duct. The octave band values can be obtained subtracting, octave by octave, from the L_{woct4} values the reflected back portion of the sound power.

The following table gives the correction factors ΔL_{wcorr} , for each fan size, that has to be applied to the corresponding L_{woct4} value.

2.2. Livello di Potenza Sonora Totale con bocca libera, L_{w6}

Il Livello di Potenza Sonora Totale, all'esterno del canale di mandata, può essere determinato in prima approssimazione usando il concetto della "End Reflection", secondo cui parte del suono prodotto dal ventilatore non esce dalla bocca del canale, ma viene riflesso all'indietro. Il valore L_{w6} , all'esterno della bocca di mandata libera (non canalizzata), può essere ritenuto approssimativamente uguale al Livello di Potenza Sonora Totale all'uscita dal canale di mandata. La rumorosità in Bande d'Ottava, all'uscita del canale di mandata o con bocca libera, può essere determinata sottraendo a L_{woct4} , per ogni Banda d'Ottava, la parte di rumore riflesso. La tabella seguente riporta i valori ΔL_{wcorr} , che devono essere applicati, per ogni grandezza, al corrispondente valore di L_{woct4} .

		Size / Grandezza												
		315	355	400	450	500	560	630	710	800	900	1000	1120	1250
ΔL_{wcorr}	63 [Hz]	-10	-10	-9	-8	-8	-7	-6	-5	-5	-4	-4	-3	-2,5
	125 [Hz]	-5,5	-5	-5	-4	-4	-3	-3	-2	-2	-1	-1	-0,5	0
	250 [Hz]	-2	-2	-2	-2	-1	-1	-1	0	0	0	0	0	0

Graph / Grafik / Graphique / Grafico n° 2.2

Note that, as L_{w6} is an estimated value, the Class 2 tolerance limit cannot be applied. Finally, please consider that the low frequencies (125 Hz and below) are strongly affected by vibrations (drive alignment, pulley unbalance, etc) and by ducts not properly acoustically insulated from the fan; the final effect is the generation of additional low frequency noise.

Si tenga presente che, essendo L_{w6} un valore calcolato, ad esso non si può applicare la tolleranza stabilita dalla Classe 2. Si consideri inoltre che la rumorosità, alle basse frequenze (125 Hz ed inferiori), è fortemente influenzata dalle vibrazioni (allineamento della trasmissione, sbilanciamento delle pulegge, ecc.) e da canalizzazioni non sufficientemente isolate acusticamente; l'effetto finale può portare ad un incremento della rumorosità alle basse frequenze.



comefri

DOUBLE INLET CENTRIFUGAL FANS WITH AIRFOIL BACKWARD CURVED BLADES WITH WELDED CASING - MAZ
 VENTILATORI CENTRIFUGHI A DOPPIA ASPIRAZIONE CON PALE A PROFILO ALARE CON COCLEA SALDATA - MAZ
 DOUBLE INLET CENTRIFUGAL FANS WITH BACKWARD CURVED BLADES WITH WELDED CASING - MHZ
 VENTILATORI CENTRIFUGHI A DOPPIA ASPIRAZIONE A PALE ROVESCE CON COCLEA SALDATA - MHZ

C-0013 February 2015

2.3. MAZ Sound data tables

2.3. Dati di rumorosità della serie MAZ

Fan model and size Ventilator-Baugröße Taille du ventilateur Grandezza del ventilatore	Volume flow range Volumenstrom Interval du debit Intervallo di portata	Speed range Drehzahl Interval de vitesse Intervallo di velocità	ΔL_{W4}	ΔL_{woc4} 63	ΔL_{woc4} 125	ΔL_{woc4} 250	ΔL_{woc4} 500	ΔL_{woc4} 1000	ΔL_{woc4} 2000	ΔL_{woc4} 4000	ΔL_{woc4} 8000
MAZ 315	Area 1	RPM \leq 2130	14,5	12	10	2	-4	-7	-11	-18	-26
		RPM \geq 2131	10,6	8	4	1	0	-7	-10	-16	-23
	Area 2	RPM \leq 2130	12,6	8	10	1	-4	-7	-10	-18	-27
		RPM \geq 2131	7,2	4	0	-4	0	-7	-9	-15	-22
	Area 3	RPM \leq 2130	10,8	7	7	1	-4	-6	-8	-16	-25
		RPM \geq 2131	7,4	5	-1	-4	-2	-6	-7	-13	-16
MAZ 355	Area 1	RPM \leq 2130	11,7	10	2	4	-5	-6	-10	-15	-22
		RPM \geq 2131	8,7	6	1	1	-3	-6	-8	-14	-20
	Area 2	RPM \leq 2130	8,7	6	0	2	-4	-5	-9	-13	-21
		RPM \geq 2131	5,0	1	-4	-3	-4	-5	-7	-12	-19
	Area 3	RPM \leq 2130	7,6	4	-1	2	-4	-5	-9	-13	-21
		RPM \geq 2131	5,3	2	-4	-5	-3	-5	-7	-12	-18
MAZ 400	Area 1	RPM \leq 1080	15,1	14	7	2	-5	-7	-11	-17	-24
		1081 \leq RPM \leq 2130	15,2	14	6	5	-3	-5	-11	-17	-25
		RPM \geq 2131	11,3	8	7	1	-4	-6	-10	-16	-23
	Area 2	RPM \leq 1080	12,0	10	5	3	-4	-6	-10	-15	-22
		1081 \leq RPM \leq 2130	11,9	10	4	3	-3	-5	-10	-16	-23
		RPM \geq 2131	7,2	4	1	-4	-3	-5	-8	-14	-21
	Area 3	RPM \leq 1080	11,9	10	5	1	-3	-5	-9	-15	-22
		1081 \leq RPM \leq 2130	11,5	10	1	2	-2	-4	-9	-15	-22
		RPM \geq 2131	6,9	4	0	-5	-3	-5	-7	-14	-20
MAZ 450	Area 1	RPM \leq 1080	15,3	14	8	2	-4	-6	-10	-15	-24
		1081 \leq RPM \leq 2130	15,2	13	10	3	-3	-5	-9	-15	-21
		RPM \geq 2131	11,9	9	7	2	-2	-5	-10	-15	-21
	Area 2	RPM \leq 1080	11,0	9	4	1	-3	-5	-10	-15	-23
		1081 \leq RPM \leq 2130	11,9	10	3	3	0	-4	-9	-15	-22
		RPM \geq 2131	4,8	0	-4	-6	-1	-4	-9	-14	-21
	Area 3	RPM \leq 1080	9,2	6	3	1	-2	-5	-10	-15	-24
		1081 \leq RPM \leq 2130	11,4	9	3	3	1	-3	-9	-14	-22
		RPM \geq 2131	4,5	-1	-4	-7	0	-5	-10	-15	-21
MAZ 500	Area 1	RPM \leq 1350	14,0	12	8	3	-4	-7	-12	-18	-25
		1351 \leq RPM \leq 2130	15,0	11	12	3	-3	-5	-12	-17	-24
		RPM \geq 2131	11,4	7	8	2	-2	-5	-12	-17	-23
	Area 2	RPM \leq 1350	11,8	10	4	2	-3	-5	-11	-17	-24
		1351 \leq RPM \leq 2130	9,4	7	1	1	-3	-4	-8	-15	-22
		RPM \geq 2131	8,1	5	2	-2	-2	-5	-10	-15	-22
	Area 3	RPM \leq 1350	8,7	5	3	1	-3	-4	-11	-18	-26
		1351 \leq RPM \leq 2130	8,0	5	0	1	-4	-4	-9	-15	-23
		RPM \geq 2131	7,8	5	0	-2	-2	-4	-10	-15	-23
MAZ 560	Area 1	RPM \leq 1080	13,3	10	9	4	-4	-7	-12	-17	-25
		1081 \leq RPM \leq 2130	13,2	9	10	3	-2	-5	-13	-17	-24
		RPM \geq 2131	10,2	7	5	1	-2	-5	-13	-18	-24
	Area 2	RPM \leq 1080	9,9	6	5	3	-4	-6	-13	-18	-26
		1081 \leq RPM \leq 2130	9,2	5	2	3	0	-4	-12	-17	-23
		RPM \geq 2131	6,0	2	-1	-3	-2	-4	-11	-17	-21
	Area 3	RPM \leq 1080	11,0	7	6	4	-1	-6	-12	-17	-24
		1081 \leq RPM \leq 2130	7,5	4	-1	1	-2	-5	-11	-15	-19
		RPM \geq 2131	5,7	2	-3	-3	-3	-3	-10	-15	-17
MAZ 630	Area 1	RPM \leq 1080	17,6	16	12	2	-3	-7	-12	-18	-25
		RPM \geq 1081	12,6	10	7	3	-1	-6	-13	-17	-20
	Area 2	RPM \leq 1080	14,7	13	9	0	-3	-7	-11	-18	-25
		RPM \geq 1081	9,7	7	2	3	-4	-6	-12	-17	-21
	Area 3	RPM \leq 1080	10,8	7	7	1	-3	-6	-11	-16	-23
		RPM \geq 1081	7,9	4	-1	3	-3	-6	-12	-15	-14



comefri

DOUBLE INLET CENTRIFUGAL FANS WITH AIRFOIL BACKWARD CURVED BLADES WITH WELDED CASING - MAZ
 VENTILATORI CENTRIFUGHI A DOPPIA ASPIRAZIONE CON PALE A PROFILO ALARE CON COCLEA SALDATA - MAZ
 DOUBLE INLET CENTRIFUGAL FANS WITH BACKWARD CURVED BLADES WITH WELDED CASING - MHZ
 VENTILATORI CENTRIFUGHI A DOPPIA ASPIRAZIONE A PALE ROVESCE CON COCLEA SALDATA - MHZ

C-0013 February 2015

Fan model and size Ventilator-Baugröße Taille du ventilateur Grandezza del ventilatore	Volume flow range Volumenstrom Interval du debit Intervallo di portata	Speed range Drehzahl Interval de vitesse Intervallo di velocità	ΔL_{W4}	ΔL_{woct4} 63	ΔL_{woct4} 125	ΔL_{woct4} 250	ΔL_{woct4} 500	ΔL_{woct4} 1000	ΔL_{woct4} 2000	ΔL_{woct4} 4000	ΔL_{woct4} 8000
MAZ 710	Area 1	RPM \leq 540	15,3	14	8	1	-4	-5	-11	-14	-21
		541 \leq RPM \leq 1080	13,7	12	7	3	-4	-5	-11	-14	-21
		RPM \geq 1081	11,8	9	6	3	-2	-5	-12	-15	-20
	Area 2	RPM \leq 540	11,5	9	6	1	-4	-5	-10	-15	-22
		541 \leq RPM \leq 1080	12,2	9	8	1	-3	-5	-11	-14	-21
		RPM \geq 1081	7,1	3	-1	2	-4	-5	-12	-16	-22
	Area 3	RPM \leq 540	12,3	10	6	3	-3	-6	-12	-16	-24
		541 \leq RPM \leq 1080	11,0	8	6	1	-3	-5	-12	-15	-24
		RPM \geq 1081	6,4	2	-2	1	-4	-4	-12	-17	-23

Fan model and size Ventilator-Baugröße Taille du ventilateur Grandezza del ventilatore	Volume flow range Volumenstrom Interval du debit Intervallo di portata	Speed range Drehzahl Interval de vitesse Intervallo di velocità	ΔL_{W4}	ΔL_{woct4} 63	ΔL_{woct4} 125	ΔL_{woct4} 250	ΔL_{woct4} 500	ΔL_{woct4} 1000	ΔL_{woct4} 2000	ΔL_{woct4} 4000	ΔL_{woct4} 8000
MAZ 800	Area 1	RPM \leq 540	13,7	12	7	2	-3	-5	-13	-17	-23
		541 \leq RPM \leq 1080	14,4	13	7	2	-3	-6	-13	-16	-23
		RPM \geq 1081	14,0	12	7	5	-3	-6	-12	-15	-22
	Area 2	RPM \leq 540	11,9	10	5	1	-2	-5	-12	-17	-24
		541 \leq RPM \leq 1080	10,2	7	5	1	-2	-5	-11	-16	-24
		RPM \geq 1081	7,2	2	0	2	-2	-5	-12	-15	-22
	Area 3	RPM \leq 540	11,2	8	6	3	-2	-6	-13	-18	-25
		541 \leq RPM \leq 1080	8,3	3	4	1	-2	-5	-11	-16	-24
		RPM \geq 1081	6,0	0	-2	1	-2	-4	-12	-16	-23

Fan model and size Ventilator-Baugröße Taille du ventilateur Grandezza del ventilatore	Volume flow range Volumenstrom Interval du debit Intervallo di portata	Speed range Drehzahl Interval de vitesse Intervallo di velocità	ΔL_{W4}	ΔL_{woct4} 63	ΔL_{woct4} 125	ΔL_{woct4} 250	ΔL_{woct4} 500	ΔL_{woct4} 1000	ΔL_{woct4} 2000	ΔL_{woct4} 4000	ΔL_{woct4} 8000
MAZ 900	Area 1	RPM \leq 540	12,7	11	5	3	-2	-5	-13	-18	-22
		541 \leq RPM \leq 1080	11,7	8	8	1	-2	-6	-13	-17	-22
		RPM \geq 1081	12,2	9	8	1	-1	-6	-13	-17	-22
	Area 2	RPM \leq 540	10,3	7	5	2	-3	-5	-13	-17	-22
		541 \leq RPM \leq 1080	10,2	5	7	1	-2	-6	-13	-17	-23
		RPM \geq 1081	9,0	5	3	2	-1	-6	-13	-17	-22
	Area 3	RPM \leq 540	11,6	9	6	2	-3	-6	-14	-19	-25
		541 \leq RPM \leq 1080	8,9	2	6	1	-2	-6	-13	-18	-24
		RPM \geq 1081	7,2	1	2	1	-1	-6	-12	-17	-23

Fan model and size Ventilator-Baugröße Taille du ventilateur Grandezza del ventilatore	Volume flow range Volumenstrom Interval du debit Intervallo di portata	Speed range Drehzahl Interval de vitesse Intervallo di velocità	ΔL_{W4}	ΔL_{woct4} 63	ΔL_{woct4} 125	ΔL_{woct4} 250	ΔL_{woct4} 500	ΔL_{woct4} 1000	ΔL_{woct4} 2000	ΔL_{woct4} 4000	ΔL_{woct4} 8000
MAZ 1000	Area 1	RPM \leq 540	14,2	13	6	1	-3	-6	-12	-17	-20
		541 \leq RPM \leq 1080	17,2	16	10	2	-2	-6	-12	-15	-22
		RPM \geq 1081	14,7	13	8	2	2	-7	-12	-17	-22
	Area 2	RPM \leq 540	11,1	9	4	1	-2	-5	-12	-17	-23
		541 \leq RPM \leq 1080	10,5	7	6	1	-2	-6	-11	-15	-22
		RPM \geq 1081	9,9	6	5	2	-2	-6	-11	-16	-21
	Area 3	RPM \leq 540	11,4	9	5	2	-2	-5	-12	-18	-25
		541 \leq RPM \leq 1080	9,9	5	6	1	-1	-4	-11	-15	-19
		RPM \geq 1081	7,7	3	2	1	-2	-6	-11	-15	-19

Fan model and size Ventilator-Baugröße Taille du ventilateur Grandezza del ventilatore	Volume flow range Volumenstrom Interval du debit Intervallo di portata	Speed range Drehzahl Interval de vitesse Intervallo di velocità	ΔL_{W4}	ΔL_{woct4} 63	ΔL_{woct4} 125	ΔL_{woct4} 250	ΔL_{woct4} 500	ΔL_{woct4} 1000	ΔL_{woct4} 2000	ΔL_{woct4} 4000	ΔL_{woct4} 8000
MAZ 1120	Area 1	RPM \leq 540	15,9	15	7	2	-2	-6	-12	-17	-20
		541 \leq RPM \leq 1080	16,1	15	8	2	-2	-7	-12	-17	-22
		RPM \geq 1081	15,3	14	8	2	-2	-6	-13	-17	-22
	Area 2	RPM \leq 540	11,9	10	5	1	-2	-6	-11	-18	-23
		541 \leq RPM \leq 1080	10,3	6	6	3	-3	-6	-11	-16	-22
		RPM \geq 1081	10,1	6	5	3	-2	-6	-11	-16	-21
	Area 3	RPM \leq 540	14,1	13	5	2	-2	-3	-11	-16	-20
		541 \leq RPM \leq 1080	9,5	5	5	2	-2	-5	-11	-15	-19
		RPM \geq 1081	8,3	4	3	1	-2	-6	-11	-14	-19

Fan model and size Ventilator-Baugröße Taille du ventilateur Grandezza del ventilatore	Volume flow range Volumenstrom Interval du debit Intervallo di portata	Speed range Drehzahl Interval de vitesse Intervallo di velocità	ΔL_{W4}	ΔL_{woct4} 63	ΔL_{woct4} 125	ΔL_{woct4} 250	ΔL_{woct4} 500	ΔL_{woct4} 1000	ΔL_{woct4} 2000	ΔL_{woct4} 4000	ΔL_{woct4} 8000
MAZ 1250	Area 1	RPM \leq 540	15,9	15	7	2	-2	-6	-12	-17	-20
		RPM \geq 541	16,1	15	8	2	-2	-7	-12	-17	-22
	Area 2	RPM \leq 540	13,5	12	6	1	-1	-6	-10	-18	-23
		RPM \geq 541	10,0	6	6	1	-3	-6	-11	-16	-22
	Area 3	RPM \leq 540	12,6	11	5	2	-2	-5	-11	-16	-20
		RPM \geq 541	9,5	5	5	2	-2	-7	-11	-15	-19



comefri

DOUBLE INLET CENTRIFUGAL FANS WITH AIRFOIL BACKWARD CURVED BLADES WITH WELDED CASING - MAZ
 VENTILATORI CENTRIFUGHI A DOPPIA ASPIRAZIONE CON PALE A PROFILO ALARE CON COCLEA SALDATA - MAZ
 DOUBLE INLET CENTRIFUGAL FANS WITH BACKWARD CURVED BLADES WITH WELDED CASING - MHZ
 VENTILATORI CENTRIFUGHI A DOPPIA ASPIRAZIONE A PALE ROVESCE CON COCLEA SALDATA - MHZ

C-0013 February 2015

2.4. MHZ Sound data tables

2.4. Dati di rumorosità della serie MHZ

Fan model and size Ventilator-Baugröße Taille du ventilateur Grandezza del ventilatore	Volume flow range Volumenstrom Interval du débit Intervallo di portata	Speed range Drehzahl Interval de vitesse Intervallo di velocità	ΔL_{W4}	ΔL_{woc4} 63	ΔL_{woc4} 125	ΔL_{woc4} 250	ΔL_{woc4} 500	ΔL_{woc4} 1000	ΔL_{woc4} 2000	ΔL_{woc4} 4000	ΔL_{woc4} 8000
MHZ 315	Area 1	RPM \leq 1940	12,7	11	5	3	-4	-7	-10	-16	-24
		RPM \geq 1941	11,3	8	7	0	-1	-6	-8	-16	-23
	Area 2	RPM \leq 1940	8,0	4	0	3	-4	-6	-8	-15	-24
		RPM \geq 1941	7,0	3	2	-4	-3	-5	-7	-14	-21
	Area 3	RPM \leq 1940	7,9	4	-1	3	-5	-6	-7	-15	-24
		RPM \geq 1941	5,5	2	-2	-6	-4	-5	-6	-12	-17

Fan model and size Ventilator-Baugröße Taille du ventilateur Grandezza del ventilatore	Volume flow range Volumenstrom Interval du débit Intervallo di portata	Speed range Drehzahl Interval de vitesse Intervallo di velocità	ΔL_{W4}	ΔL_{woc4} 63	ΔL_{woc4} 125	ΔL_{woc4} 250	ΔL_{woc4} 500	ΔL_{woc4} 1000	ΔL_{woc4} 2000	ΔL_{woc4} 4000	ΔL_{woc4} 8000
MHZ 355	Area 1	RPM \leq 1940	11,6	10	3	2	-5	-6	-8	-13	-22
		RPM \geq 1941	9,1	7	1	-1	-3	-5	-7	-14	-21
	Area 2	RPM \leq 1940	8,3	6	-2	1	-5	-5	-7	-13	-22
		RPM \geq 1941	3,8	-2	-4	-4	-4	-5	-7	-13	-20
	Area 3	RPM \leq 1940	6,7	3	-3	1	-5	-5	-7	-13	-22
		RPM \geq 1941	4,2	0	-4	-6	-4	-5	-7	-12	-19

Fan model and size Ventilator-Baugröße Taille du ventilateur Grandezza del ventilatore	Volume flow range Volumenstrom Interval du débit Intervallo di portata	Speed range Drehzahl Interval de vitesse Intervallo di velocità	ΔL_{W4}	ΔL_{woc4} 63	ΔL_{woc4} 125	ΔL_{woc4} 250	ΔL_{woc4} 500	ΔL_{woc4} 1000	ΔL_{woc4} 2000	ΔL_{woc4} 4000	ΔL_{woc4} 8000
MHZ 400	Area 1	RPM \leq 980	12,2	10	6	3	-5	-6	-11	-18	-24
		981 \leq RPM \leq 1940	13,3	12	2	5	-5	-6	-11	-18	-24
		RPM \geq 1941	8,5	6	1	-1	-3	-5	-9	-16	-23
	Area 2	RPM \leq 980	9,8	7	3	3	-5	-7	-11	-17	-24
		981 \leq RPM \leq 1940	10,9	9	-3	5	-5	-7	-11	-17	-24
		RPM \geq 1941	5,8	2	-1	-3	-4	-5	-7	-14	-22
	Area 3	RPM \leq 980	8,6	5	3	1	-4	-5	-9	-15	-23
		981 \leq RPM \leq 1940	8,2	5	-3	3	-4	-5	-9	-15	-23
		RPM \geq 1941	5,9	3	-2	-5	-3	-6	-8	-13	-22

Fan model and size Ventilator-Baugröße Taille du ventilateur Grandezza del ventilatore	Volume flow range Volumenstrom Interval du débit Intervallo di portata	Speed range Drehzahl Interval de vitesse Intervallo di velocità	ΔL_{W4}	ΔL_{woc4} 63	ΔL_{woc4} 125	ΔL_{woc4} 250	ΔL_{woc4} 500	ΔL_{woc4} 1000	ΔL_{woc4} 2000	ΔL_{woc4} 4000	ΔL_{woc4} 8000
MHZ 450	Area 1	RPM \leq 980	10,9	8	6	1	-5	-5	-10	-15	-23
		981 \leq RPM \leq 1940	11,0	9	4	1	-5	-5	-10	-15	-23
		RPM \geq 1941	11,5	10	3	0	-3	-4	-9	-15	-22
	Area 2	RPM \leq 980	6,4	2	1	-2	-5	-4	-9	-14	-23
		981 \leq RPM \leq 1940	6,2	3	-3	-1	-5	-4	-9	-14	-23
		RPM \geq 1941	3,5	-2	-5	-8	-3	-4	-8	-13	-21
	Area 3	RPM \leq 980	5,6	0	0	-2	-4	-4	-8	-13	-22
		981 \leq RPM \leq 1940	5,5	1	-3	-1	-4	-4	-8	-13	-22
		RPM \geq 1941	3,9	-2	-3	-6	-3	-5	-8	-11	-17

Fan model and size Ventilator-Baugröße Taille du ventilateur Grandezza del ventilatore	Volume flow range Volumenstrom Interval du débit Intervallo di portata	Speed range Drehzahl Interval de vitesse Intervallo di velocità	ΔL_{W4}	ΔL_{woc4} 63	ΔL_{woc4} 125	ΔL_{woc4} 250	ΔL_{woc4} 500	ΔL_{woc4} 1000	ΔL_{woc4} 2000	ΔL_{woc4} 4000	ΔL_{woc4} 8000
MHZ 500	Area 1	RPM \leq 1230	11,4	8	7	2	-4	-5	-11	-17	-23
		1231 \leq RPM \leq 1940	10,7	8	5	2	-4	-5	-11	-17	-23
		RPM \geq 1941	14,7	14	4	0	-3	-4	-10	-16	-23
	Area 2	RPM \leq 1230	7,1	2	2	0	-4	-4	-9	-15	-23
		1231 \leq RPM \leq 1940	6,6	2	-1	1	-4	-4	-9	-15	-23
		RPM \geq 1941	3,8	-2	-5	-7	-2	-3	-10	-15	-22
	Area 3	RPM \leq 1230	7,0	3	1	-1	-4	-4	-8	-13	-22
		1231 \leq RPM \leq 1940	6,8	3	-3	1	-4	-4	-8	-13	-22
		RPM \geq 1941	4,5	-1	-4	-4	-2	-4	-9	-13	-19

Fan model and size Ventilator-Baugröße Taille du ventilateur Grandezza del ventilatore	Volume flow range Volumenstrom Interval du débit Intervallo di portata	Speed range Drehzahl Interval de vitesse Intervallo di velocità	ΔL_{W4}	ΔL_{woc4} 63	ΔL_{woc4} 125	ΔL_{woc4} 250	ΔL_{woc4} 500	ΔL_{woc4} 1000	ΔL_{woc4} 2000	ΔL_{woc4} 4000	ΔL_{woc4} 8000
MHZ 560	Area 1	RPM \leq 980	10,1	6	6	2	-4	-5	-12	-17	-23
		981 \leq RPM \leq 1940	10,1	7	4	3	-4	-5	-12	-17	-23
		RPM \geq 1941	8,7	6	2	-1	-3	-4	-11	-17	-23
	Area 2	RPM \leq 980	8,6	5	3	1	-4	-4	-11	-17	-24
		981 \leq RPM \leq 1940	8,7	6	0	2	-4	-4	-11	-17	-24
		RPM \geq 1941	4,6	0	-3	-6	-2	-4	-10	-16	-22
	Area 3	RPM \leq 980	7,7	2	3	1	-3	-4	-10	-16	-23
		981 \leq RPM \leq 1940	7,3	3	-1	2	-3	-4	-10	-16	-23
		RPM \geq 1941	4,5	-1	-4	-5	-1	-4	-10	-15	-19



comefri

DOUBLE INLET CENTRIFUGAL FANS WITH AIRFOIL BACKWARD CURVED BLADES WITH WELDED CASING - MAZ
 VENTILATORI CENTRIFUGHI A DOPPIA ASPIRAZIONE CON PALE A PROFILO ALARE CON COCLEA SALDATA - MAZ
 DOUBLE INLET CENTRIFUGAL FANS WITH BACKWARD CURVED BLADES WITH WELDED CASING - MHZ
 VENTILATORI CENTRIFUGHI A DOPPIA ASPIRAZIONE A PALE ROVESCE CON COCLEA SALDATA - MHZ

C-0013 February 2015

Fan model and size Ventilator-Baugröße Taille du ventilateur Grandezza del ventilatore	Volume flow range Volumenstrom Interval du debit Intervallo di portata	Speed range Drehzahl Interval de vitesse Intervallo di velocità	ΔL_{W4}	ΔL_{woc4} 63	ΔL_{woc4} 125	ΔL_{woc4} 250	ΔL_{woc4} 500	ΔL_{woc4} 1000	ΔL_{woc4} 2000	ΔL_{woc4} 4000	ΔL_{woc4} 8000
MHZ 630	Area 1	RPM \leq 980	11,8	9	7	1	-4	-5	-11	-16	-24
		RPM \geq 981	9,7	6	5	1	-4	-4	-10	-16	-24
	Area 2	RPM \leq 980	8,5	0	6	1	-4	-5	-10	-16	-24
		RPM \geq 981	4,1	-3	-5	-1	-4	-4	-10	-15	-24

Fan model and size Ventilator-Baugröße Taille du ventilateur Grandezza del ventilatore	Volume flow range Volumenstrom Interval du debit Intervallo di portata	Speed range Drehzahl Interval de vitesse Intervallo di velocità	ΔL_{W4}	ΔL_{woc4} 63	ΔL_{woc4} 125	ΔL_{woc4} 250	ΔL_{woc4} 500	ΔL_{woc4} 1000	ΔL_{woc4} 2000	ΔL_{woc4} 4000	ΔL_{woc4} 8000
MHZ 710	Area 1	RPM \leq 490	7,0	3	0	0	-4	-3	-11	-17	-25
		491 \leq RPM \leq 980	12,7	11	6	1	-3	-5	-12	-16	-23
		RPM \geq 981	8,8	6	2	1	-5	-4	-13	-17	-24
	Area 2	RPM \leq 490	10,4	8	4	1	-3	-4	-12	-17	-25
		491 \leq RPM \leq 980	10,4	8	4	1	-3	-4	-12	-17	-25
		RPM \geq 981	5,6	1	-4	0	-4	-3	-11	-17	-25

Fan model and size Ventilator-Baugröße Taille du ventilateur Grandezza del ventilatore	Volume flow range Volumenstrom Interval du debit Intervallo di portata	Speed range Drehzahl Interval de vitesse Intervallo di velocità	ΔL_{W4}	ΔL_{woc4} 63	ΔL_{woc4} 125	ΔL_{woc4} 250	ΔL_{woc4} 500	ΔL_{woc4} 1000	ΔL_{woc4} 2000	ΔL_{woc4} 4000	ΔL_{woc4} 8000
MHZ 800	Area 1	RPM \leq 490	13,5	12	5	4	-5	-6	-11	-18	-24
		491 \leq RPM \leq 980	10,1	7	5	1	-3	-5	-13	-18	-25
		RPM \geq 981	9,2	6	3	1	-3	-4	-11	-16	-24
	Area 2	RPM \leq 490	7,4	2	2	1	-2	-5	-12	-16	-25
		RPM \geq 981	6,2	0	-2	2	-3	-5	-11	-16	-23
	Area 3	RPM \leq 490	8,2	5	1	1	-4	-5	-9	-15	-23
491 \leq RPM \leq 980		7,0	1	2	1	-3	-5	-12	-18	-26	
RPM \geq 981	5,0	-2	-3	0	-3	-4	-10	-16	-24		

Fan model and size Ventilator-Baugröße Taille du ventilateur Grandezza del ventilatore	Volume flow range Volumenstrom Interval du debit Intervallo di portata	Speed range Drehzahl Interval de vitesse Intervallo di velocità	ΔL_{W4}	ΔL_{woc4} 63	ΔL_{woc4} 125	ΔL_{woc4} 250	ΔL_{woc4} 500	ΔL_{woc4} 1000	ΔL_{woc4} 2000	ΔL_{woc4} 4000	ΔL_{woc4} 8000
MHZ 900	Area 1	RPM \leq 490	11,0	8	6	0	-1	-5	-13	-19	-24
		491 \leq RPM \leq 980	10,7	8	5	0	-1	-5	-13	-19	-24
		RPM \geq 981	10,2	7	5	1	-2	-5	-12	-18	-25
	Area 2	RPM \leq 490	8,7	5	3	0	-1	-5	-13	-19	-26
		491 \leq RPM \leq 980	8,0	2	4	0	-1	-5	-13	-19	-26
		RPM \geq 981	5,9	-2	-1	1	-1	-5	-12	-18	-26

Fan model and size Ventilator-Baugröße Taille du ventilateur Grandezza del ventilatore	Volume flow range Volumenstrom Interval du debit Intervallo di portata	Speed range Drehzahl Interval de vitesse Intervallo di velocità	ΔL_{W4}	ΔL_{woc4} 63	ΔL_{woc4} 125	ΔL_{woc4} 250	ΔL_{woc4} 500	ΔL_{woc4} 1000	ΔL_{woc4} 2000	ΔL_{woc4} 4000	ΔL_{woc4} 8000
MHZ 1000	Area 1	RPM \leq 490	11,9	10	5	0	-1	-5	-12	-18	-25
		491 \leq RPM \leq 980	11,9	10	5	0	-1	-5	-12	-18	-25
		RPM \geq 981	10,8	8	3	4	-1	-5	-12	-18	-25
	Area 2	RPM \leq 490	7,9	2	4	0	-2	-5	-11	-17	-24
		491 \leq RPM \leq 980	7,9	2	4	0	-2	-5	-11	-17	-24
		RPM \geq 981	7,9	2	2	3	-2	-5	-11	-17	-24

Fan model and size Ventilator-Baugröße Taille du ventilateur Grandezza del ventilatore	Volume flow range Volumenstrom Interval du debit Intervallo di portata	Speed range Drehzahl Interval de vitesse Intervallo di velocità	ΔL_{W4}	ΔL_{woc4} 63	ΔL_{woc4} 125	ΔL_{woc4} 250	ΔL_{woc4} 500	ΔL_{woc4} 1000	ΔL_{woc4} 2000	ΔL_{woc4} 4000	ΔL_{woc4} 8000
MHZ 1120	Area 1	RPM \leq 490	13,5	12	6	1	0	-5	-12	-18	-25
		491 \leq RPM \leq 980	12,6	11	5	1	0	-5	-12	-20	-25
		RPM \geq 981	11,8	9	5	4	0	-4	-13	-18	-25
	Area 2	RPM \leq 490	9,4	5	5	0	-1	-3	-10	-15	-19
		491 \leq RPM \leq 980	8,6	4	4	1	-2	-6	-11	-17	-24
		RPM \geq 981	8,5	3	3	3	-2	-5	-11	-16	-24

Fan model and size Ventilator-Baugröße Taille du ventilateur Grandezza del ventilatore	Volume flow range Volumenstrom Interval du debit Intervallo di portata	Speed range Drehzahl Interval de vitesse Intervallo di velocità	ΔL_{W4}	ΔL_{woc4} 63	ΔL_{woc4} 125	ΔL_{woc4} 250	ΔL_{woc4} 500	ΔL_{woc4} 1000	ΔL_{woc4} 2000	ΔL_{woc4} 4000	ΔL_{woc4} 8000
MHZ 1250	Area 1	RPM \leq 490	13,5	12	6	1	0	-5	-12	-18	-25
		RPM \geq 491	12,6	11	5	1	0	-5	-12	-20	-25
	Area 2	RPM \leq 490	9,4	5	5	0	-1	-3	-10	-15	-19
		RPM \geq 491	8,6	4	4	1	-2	-6	-11	-17	-24

3. MAZ Performance charts

3. Curve caratteristiche della serie MAZ



MAZ 315		T1	T2
Fan Max RPM / Max zul. Ventilator-drehzahl / Vitesse de rotation maximale / Massima velocità di rotazione	[min ⁻¹]	4000	
Fan Max power / Max zul. Ventilatorwellenleistung / Puissance absorbée maximale / Potenza massima assorbita	[kW]	7,5	11
Wheel diameter / Laufraddurchmesser / Diamètre nominale de la turbine / Diametro nominale della girante	[mm]	325	
Wheel No. Blades / Schaufelanzahl / Nombre d'aubes / N° di pale	z	10	
Wheel Moment of Inertia / Laufrad Massenträgheitsmoment / Moment d'inertie de la turbine / Momento d'inerzia della girante	[kg m ²]	0,14	
Wheel weight / Laufradgewicht / Poids de la turbine / Peso della girante	[kg]	7,1	

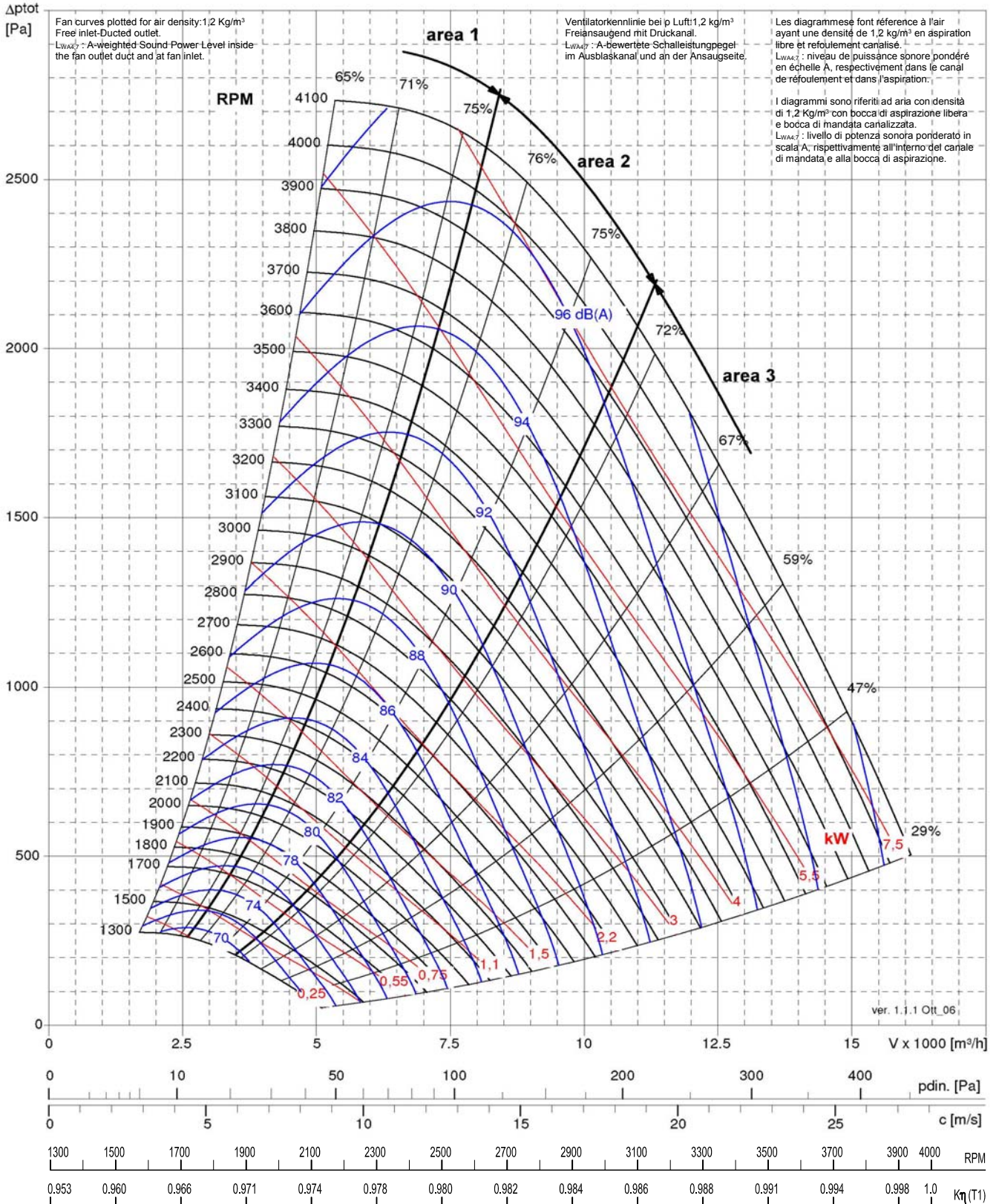



MAZ 355		T1	T2
Fan Max RPM / Max zul. Ventilator-drehzahl / Vitesse de rotation maximale / Massa velocità di rotazione	[min ⁻¹]	3650	4000
Fan Max power / Max zul. Ventilatorwellenleistung / Puissance absorbée maximale / Potenza massima assorbita	[kW]	9	12
Wheel diameter / Laufraddurchmesser / Diamètre nominale de la turbine / Diametro nominale della girante	[mm]	365	
Wheel No. Blades / Schaufelanzahl / Nombre d'aubes / N° di pale	z	10	
Wheel Moment of Inertia / Laufrad Massenträgheitsmoment / Moment d'inertie de la turbine / Momento d'inertzia della girante	[kg m ²]	0,21	0,25
Wheel weight / Laufradgewicht / Poids de la turbine / Peso della girante	[kg]	8,4	12,4

Δp_{tot}
[Pa]

Fan curves plotted for air density: 1.2 Kg/m³
Free inlet-Ducted outlet.
L_{WA,1}: A-weighted Sound Power Level inside
the fan outlet duct and at fan inlet.

Ventilator-kennlinie bei ρ Luft: 1.2 kg/m³
Freiansaugend mit Druckkanal.
L_{WA,1}: A-bewertete Schalleistungspegel
im Ausblaskanal und an der Ansaugseite.

Les diagrammes font référence à l'air
ayant une densité de 1.2 kg/m³ en aspiration
libre et refoulement canalisé.
L_{WA,1}: niveau de puissance sonore pondéré
en échelle A, respectivement dans le canal
de refoulement et dans l'aspiration.

I diagrammi sono riferiti ad aria con densità
di 1,2 Kg/m³ con bocca di aspirazione libera
e bocca di mandata canalizzata.
L_{WA,1}: livello di potenza sonora ponderato in
scala A, rispettivamente all'interno del canale
di mandata e alla bocca di aspirazione.

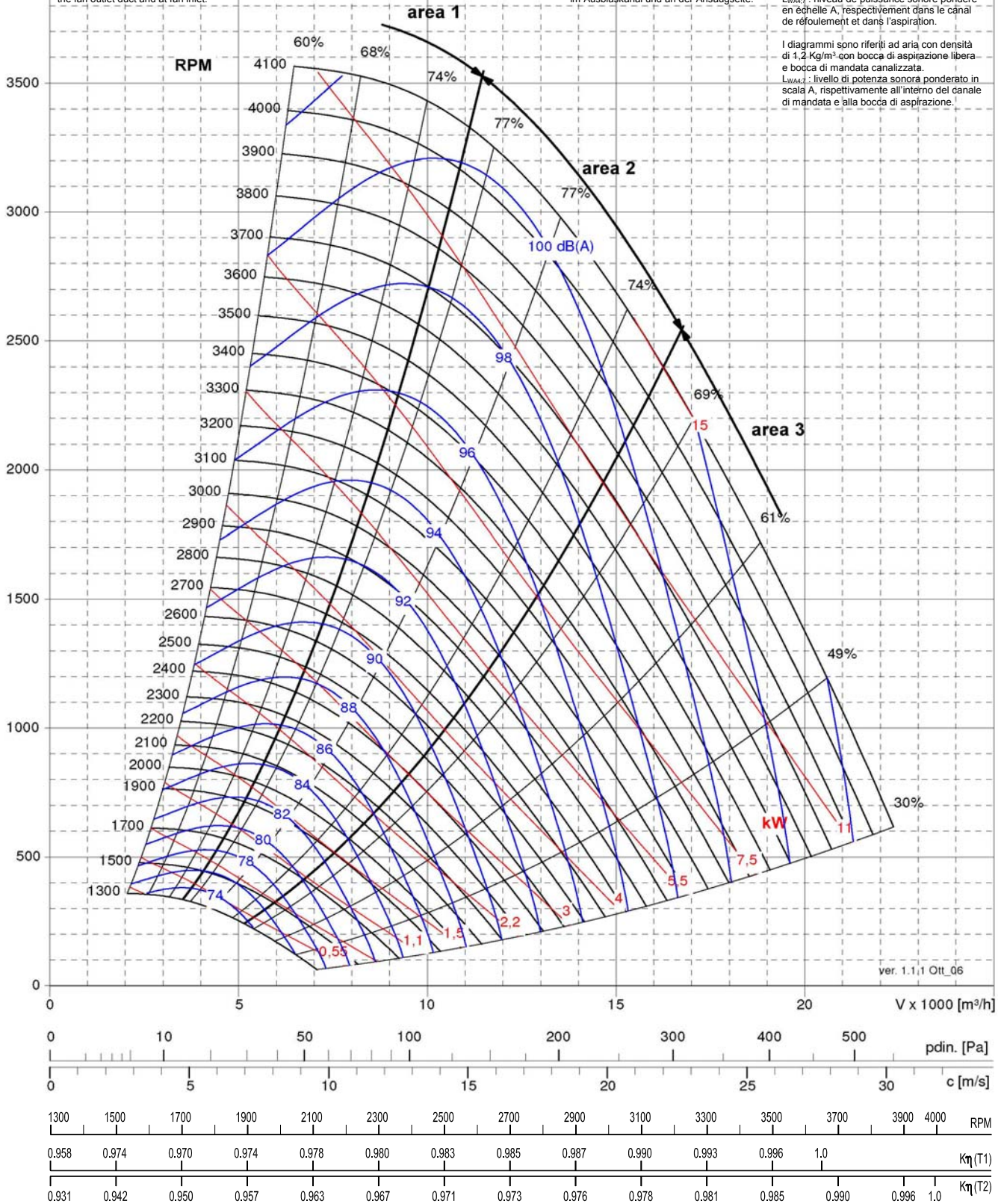



MAZ 400		T1	T2L	T2
Fan Max RPM / Max zul. Ventilator Drehzahl / Vitesse de rotation maximale / Massima velocità di rotazione	[min ⁻¹]	3200	3215	3700
Fan Max power / Max zul. Ventilatorwellenleistung / Puissance absorbée maximale / Potenza massima assorbita	[kW]	9	11	14
Wheel diameter / Laufraddurchmesser / Diamètre nominale de la turbine / Diametro nominale della girante	[mm]	412		
Wheel No. Blades / Schaufelanzahl / Nombre d'aubes / N° di pale	z	10		
Wheel Moment of Inertia / Laufrad Massenträgheitsmoment / Moment d'inertie de la turbine / Momento d'inertzia della girante	[kg m ²]	0,33	0,41	0,41
Wheel weight / Laufradgewicht / Poids de la turbine / Peso della girante	[kg]	11	14,4	14,4

Δp_{tot}
[Pa]

Fan curves plotted for air density: 1.2 Kg/m³
Free inlet-Ducted outlet.
 L_{WAk1} : A-weighted Sound Power Level inside the fan outlet duct and at fan inlet.

Ventilator Kennlinie bei ρ Luft: 1.2 kg/m³
Freiansaugend mit Druckkanal.
 L_{WAk1} : A-bewertete Schalleistungsebene im Ausblaskanal und an der Ansaugseite.

Les diagrammes font référence à l'air ayant une densité de 1.2 kg/m³ en aspiration libre et refoulement canalisé.
 L_{WAk1} : niveau de puissance sonore pondéré en échelle A, respectivement dans le canal de refoulement et dans l'aspiration.

I diagrammi sono riferiti ad aria con densità di 1.2 Kg/m³ con bocca di aspirazione libera e bocca di mandata canalizzata.
 L_{WAk1} : livello di potenza sonora ponderato in scala A, rispettivamente all'interno del canale di mandata e alla bocca di aspirazione.

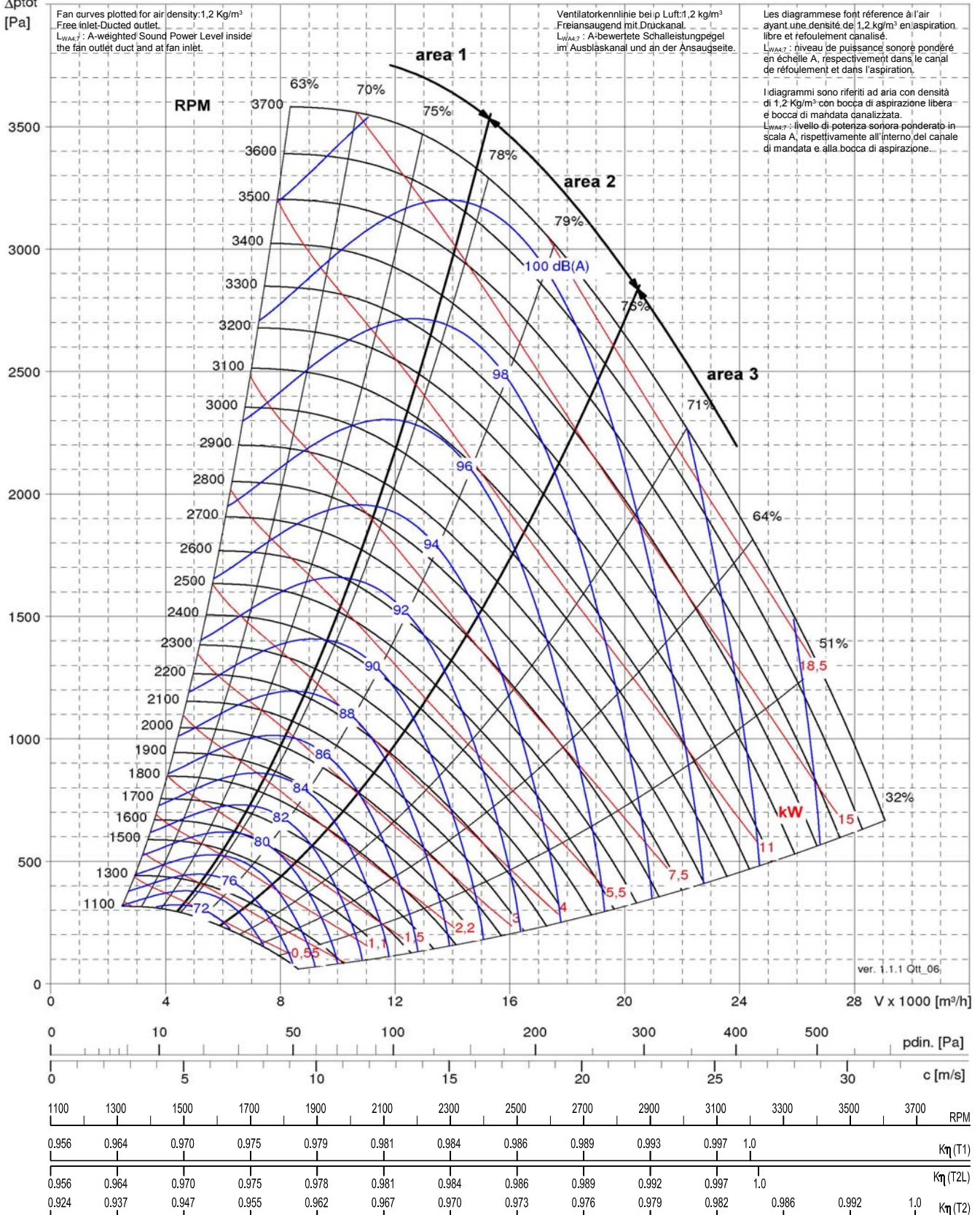

ver. 1.1.1 Ott. 06



MAZ 450		T1	T2L	T2
Fan Max RPM / Max zul. Ventilator-drehzahl / Vitesse de rotation maximale / Massima velocità di rotazione	[min ⁻¹]	2850	2950	3300
Fan Max power / Max zul. Ventilatorwellenleistung / Puissance absorbée maximale / Potenza massima assorbita	[kW]	13	16	18,5
Wheel diameter / Laufraddurchmesser / Diamètre nominale de la turbine / Diametro nominale della girante	[mm]	462		
Wheel No. Blades / Schaufelanzahl / Nombre d'aubes / N° di pale	z	10		
Wheel Moment of Inertia / Laufrad Massenträgheitsmoment / Moment d'inertie de la turbine / Momento d'inertzia della girante	[kg m ²]	0,56	0,67	0,67
Wheel weight / Laufradgewicht / Poids de la turbine / Peso della girante	[kg]	15	19,1	19,1

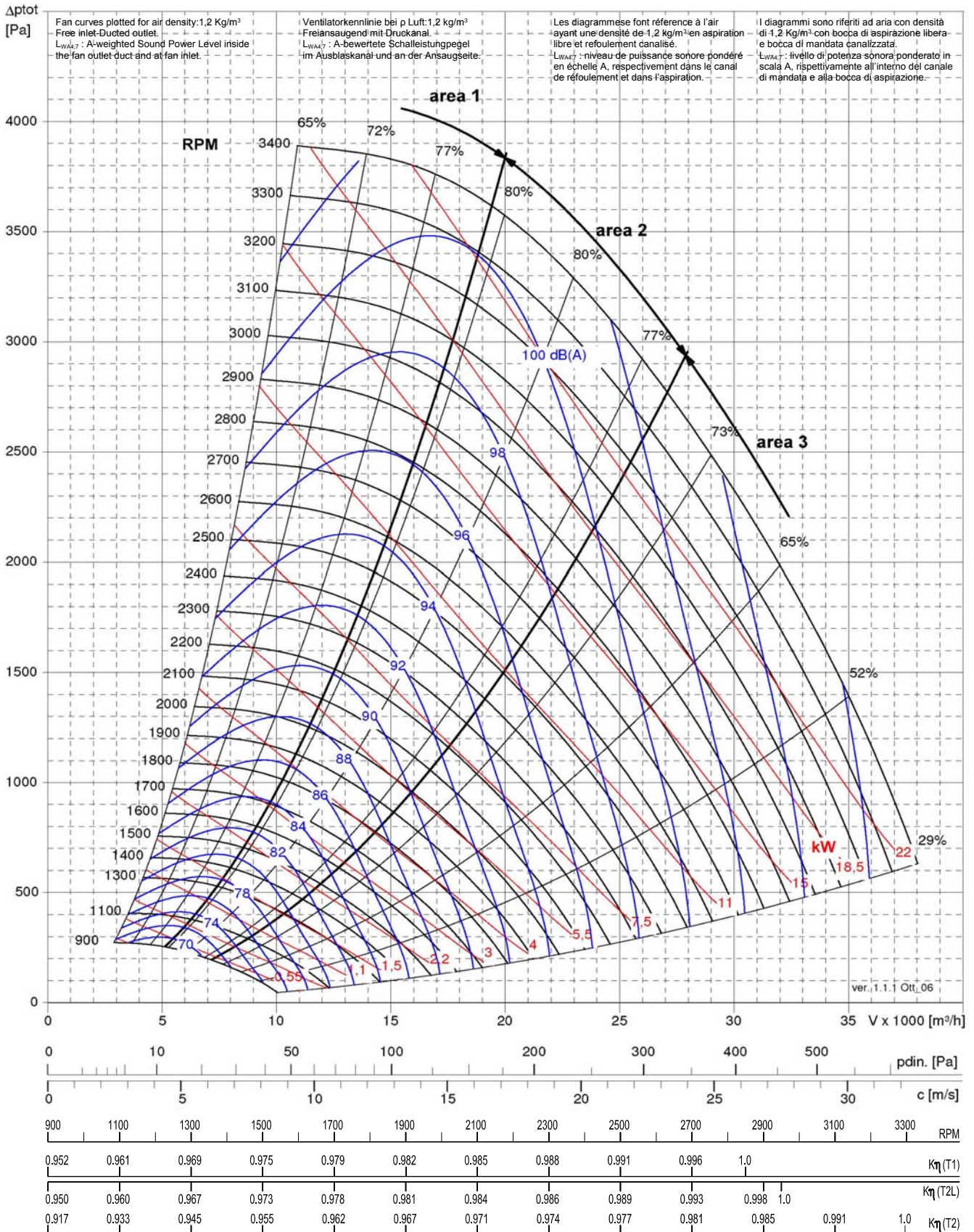



MAZ 500		T1	T2L	T2
Fan Max RPM / Max zul. Ventilator-drehzahl / Vitesse de rotation maximale / Massima velocità di rotazione	[min ⁻¹]	2300	2500	2820
Fan Max power / Max zul. Ventilatorwellenleistung / Puissance absorbée maximale / Potenza massima assorbita	[kW]	13	16	22
Wheel diameter / Laufraddurchmesser / Diamètre nominale de la turbine / Diametro nominale della girante	[mm]	513		
Wheel No. Blades / Schaufelanzahl / Nombre d'aubes / N° di pale	z	10		
Wheel Moment of Inertia / Laufrad Massenträgheitsmoment / Moment d'inertie de la turbine / Momento d'inertzia della girante	[kg m ²]	1,15	1,33	1,33
Wheel weight / Laufradgewicht / Poids de la turbine / Peso della girante	[kg]	26	30,1	30,1

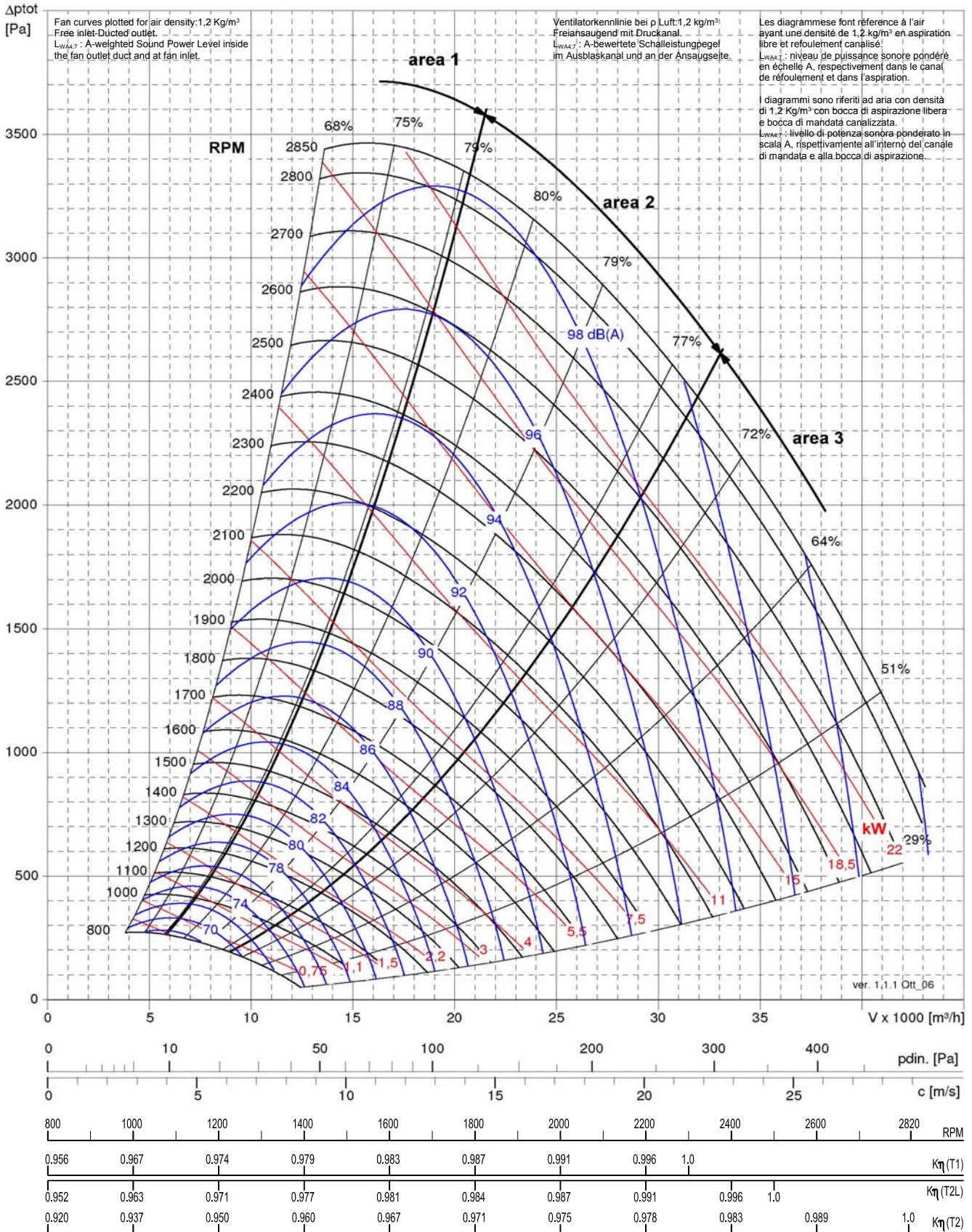



MAZ 560		T1	T2L	T2
Fan Max RPM / Max zul. Ventilator Drehzahl / Vitesse de rotation maximale / Massima velocità di rotazione	[min ⁻¹]	2200	2650	2700
Fan Max power / Max zul. Ventilatorwellenleistung / Puissance absorbée maximale / Potenza massima assorbita	[kW]	18,5	35	35
Wheel diameter / Laufraddurchmesser / Diamètre nominale de la turbine / Diametro nominale della girante	[mm]	575		
Wheel No. Blades / Schaufelanzahl / Nombre d'aubes / N° di pale	z	10		
Wheel Moment of Inertia / Laufrad Massenträgheitsmoment / Moment d'inertie de la turbine / Momento d'inertzia della girante	[kg m ²]	1,8	2	2
Wheel weight / Laufradgewicht / Poids de la turbine / Peso della girante	[kg]	29,3	35,9	35,9

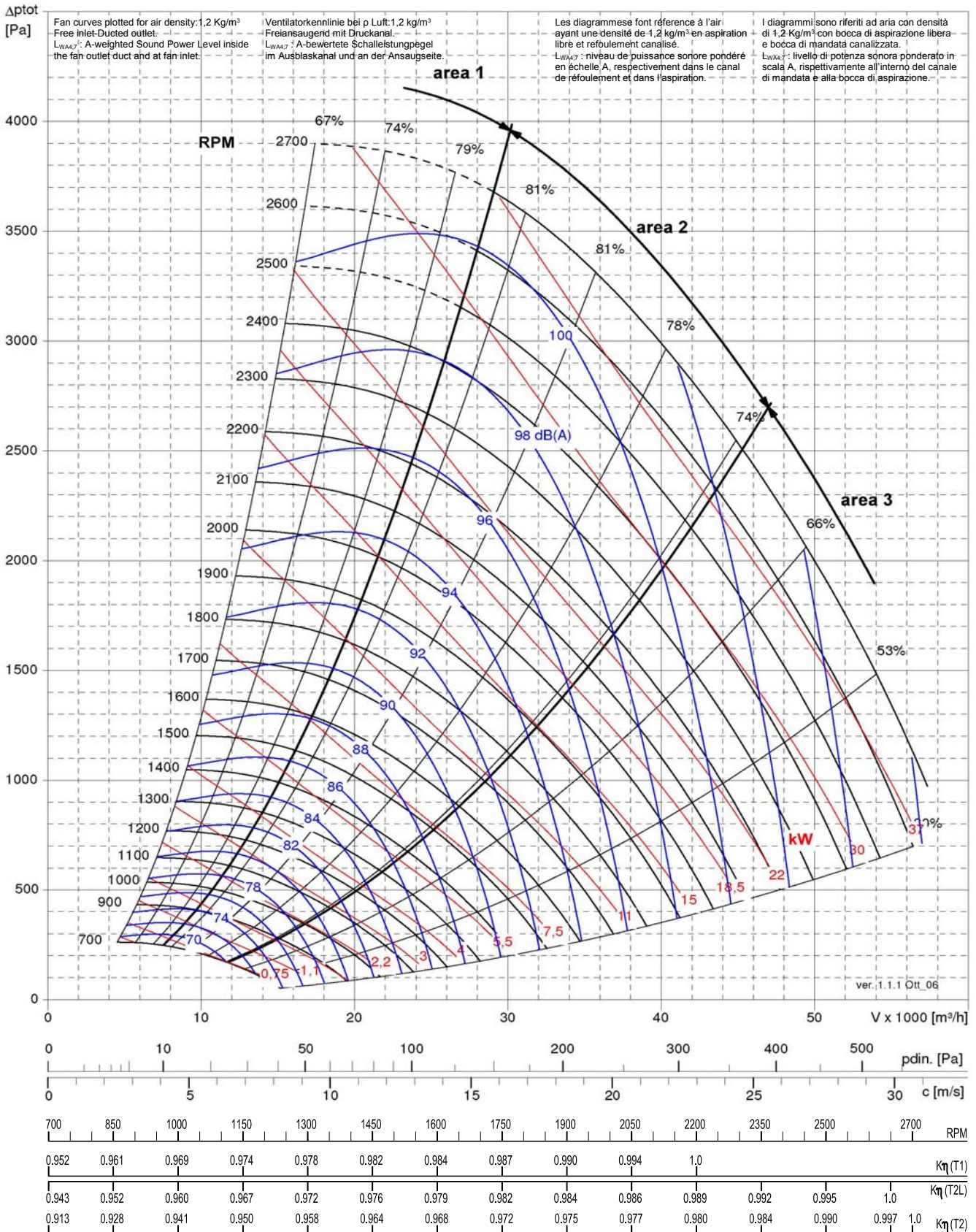



MAZ 630		T1	T2L	T2
Fan Max RPM / Max zul. Ventilator-drehzahl / Vitesse de rotation maximale / Massima velocità di rotazione	[min ⁻¹]	1700	2250	2350
Fan Max power / Max zul. Ventilatorwellenleistung / Puissance absorbée maximale / Potenza massima assorbita	[kW]	18,5	35	40
Wheel diameter / Laufraddurchmesser / Diamètre nominale de la turbine / Diametro nominale della girante	[mm]	646		
Wheel No. Blades / Schaufelanzahl / Nombre d'aubes / N° di pale	z	10		
Wheel Moment of Inertia / Laufrad Massenträgheitsmoment / Moment d'inertie de la turbine / Momento d'inertzia della girante	[kg m ²]	2,94	3,21	3,21
Wheel weight / Laufradgewicht / Poids de la turbine / Peso della girante	[kg]	42,3	48,9	48,9

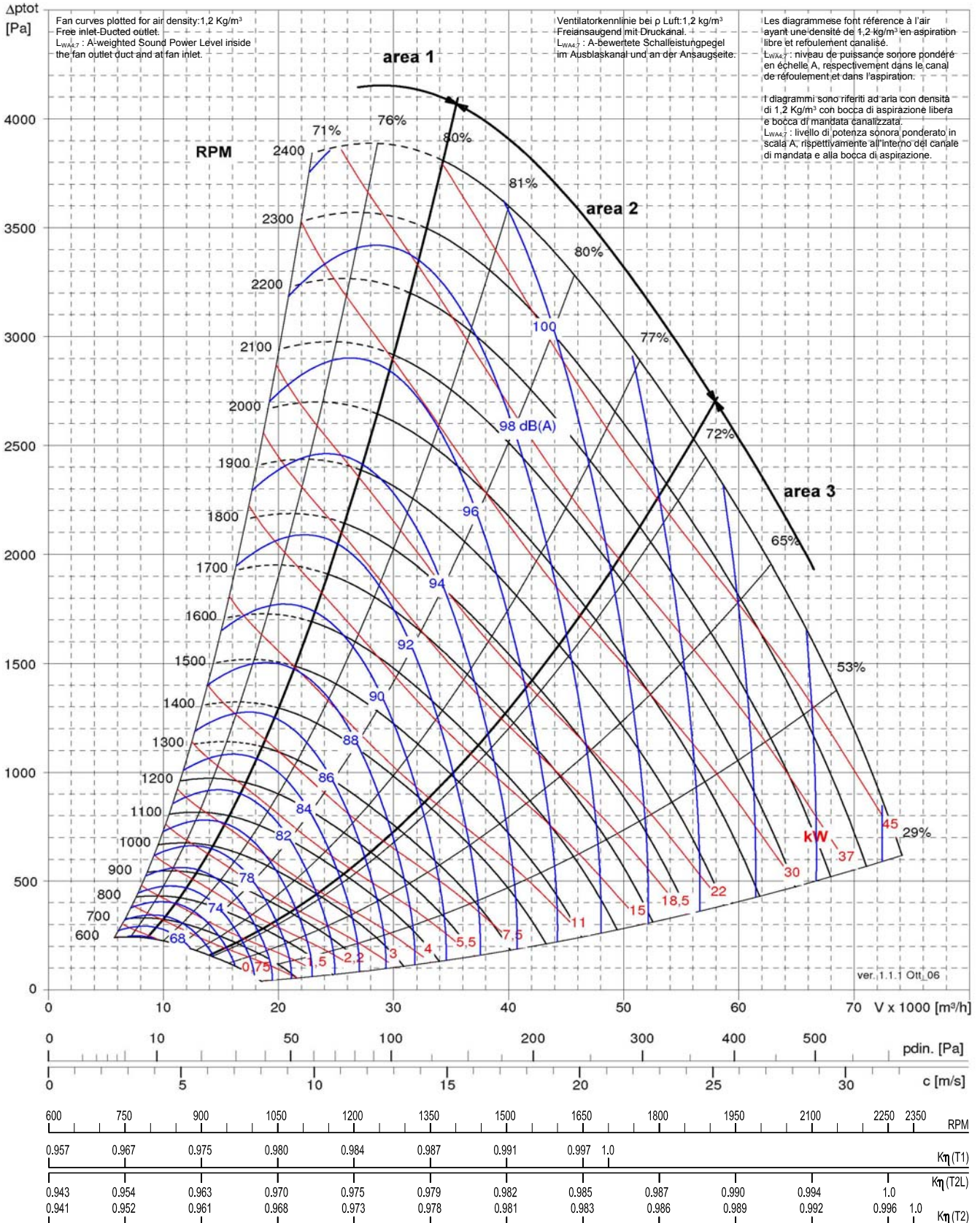



MAZ 710		T1	T2L	T2
Fan Max RPM / Max zul. Ventilator Drehzahl / Vitesse de rotation maximale / Massima velocità di rotazione	[min ⁻¹]	1700	1850	2100
Fan Max power / Max zul. Ventilatorwellenleistung / Puissance absorbée maximale / Potenza massima assorbita	[kW]	22	40	45
Wheel diameter / Laufraddurchmesser / Diamètre nominale de la turbine / Diametro nominale della girante	[mm]	722		
Wheel No. Blades / Schaufelanzahl / Nombre d'aubes / N° di pale	z	10		
Wheel Moment of Inertia / Laufrad Massenträgheitsmoment / Moment d'inertie de la turbine / Momento d'inertzia della girante	[kg m ²]	5,5	5,7	5,7
Wheel weight / Laufradgewicht / Poids de la turbine / Peso della girante	[kg]	63	64,3	64,3

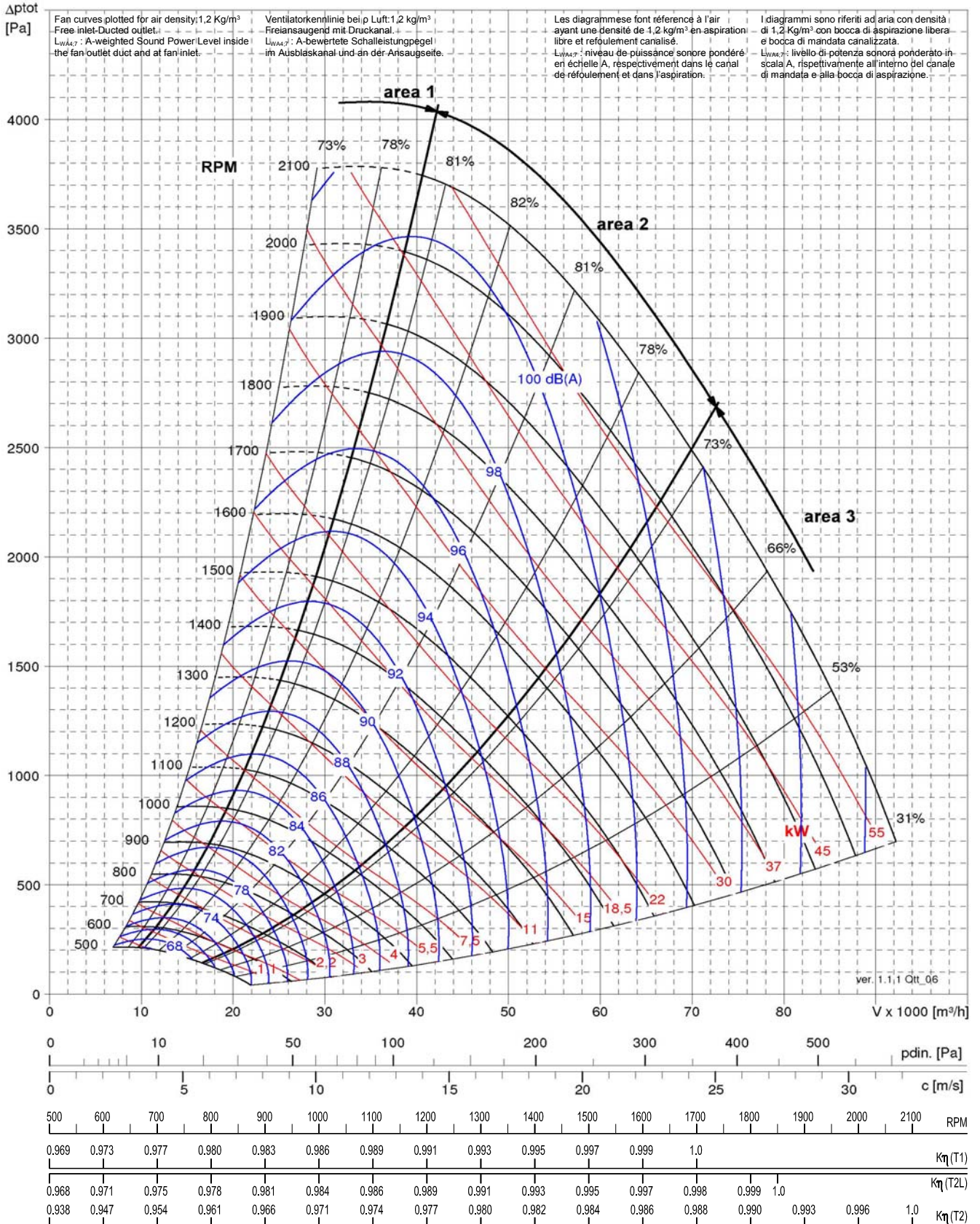



MAZ 800		T1	T2L	T2
Fan Max RPM / Max zul. Ventilator-drehzahl / Vitesse de rotation maximale / Massima velocità di rotazione	[min ⁻¹]	1300	1650	1800
Fan Max power / Max zul. Ventilatorwellenleistung / Puissance absorbée maximale / Potenza massima assorbita	[kW]	22	40	50
Wheel diameter / Laufraddurchmesser / Diamètre nominale de la turbine / Diametro nominale della girante	[mm]	813		
Wheel No. Blades / Schaufelanzahl / Nombre d'aubes / N° di pale	z	10		
Wheel Moment of Inertia / Laufrad Massenträgheitsmoment / Moment d'inertie de la turbine / Momento d'inertzia della girante	[kg m ²]	9,1	9,2	9,2
Wheel weight / Laufradgewicht / Poids de la turbine / Peso della girante	[kg]	80,2	82	82

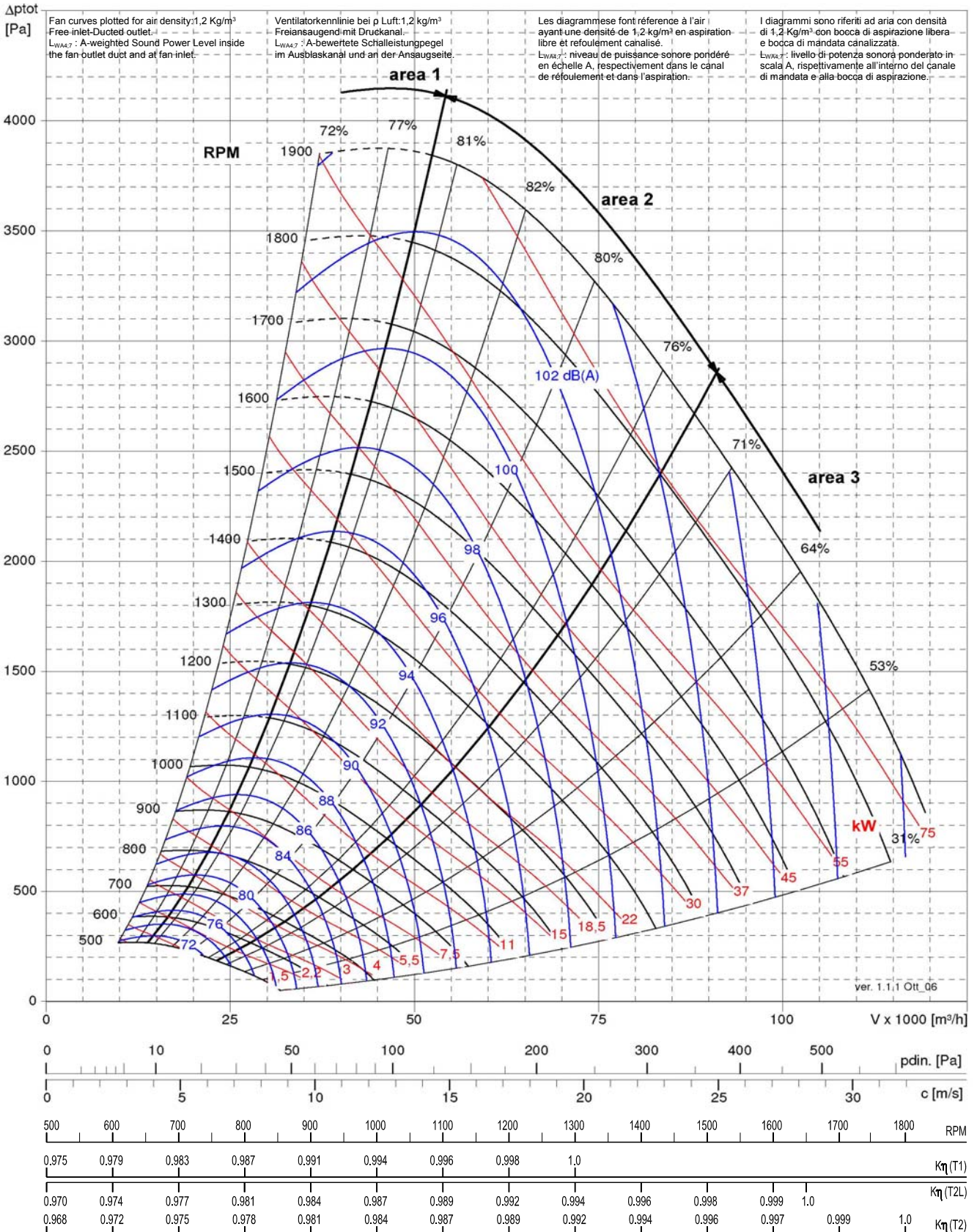



MAZ 900		T1	T2L	T2
Fan Max RPM / Max zul. Ventilator Drehzahl / Vitesse de rotation maximale / Massima velocità di rotazione	[min ⁻¹]	1300	1450	1600
Fan Max power / Max zul. Ventilatorwellenleistung / Puissance absorbée maximale / Potenza massima assorbita	[kW]	33	47	70
Wheel diameter / Laufraddurchmesser / Diamètre nominale de la turbine / Diametro nominale della girante	[mm]	913		
Wheel No. Blades / Schaufelanzahl / Nombre d'aubes / N° di pale	z	10		
Wheel Moment of Inertia / Laufrad Massenträgheitsmoment / Moment d'inertie de la turbine / Momento d'inertzia della girante	[kg m ²]	15,5	17	17
Wheel weight / Laufradgewicht / Poids de la turbine / Peso della girante	[kg]	112	116,2	116,2

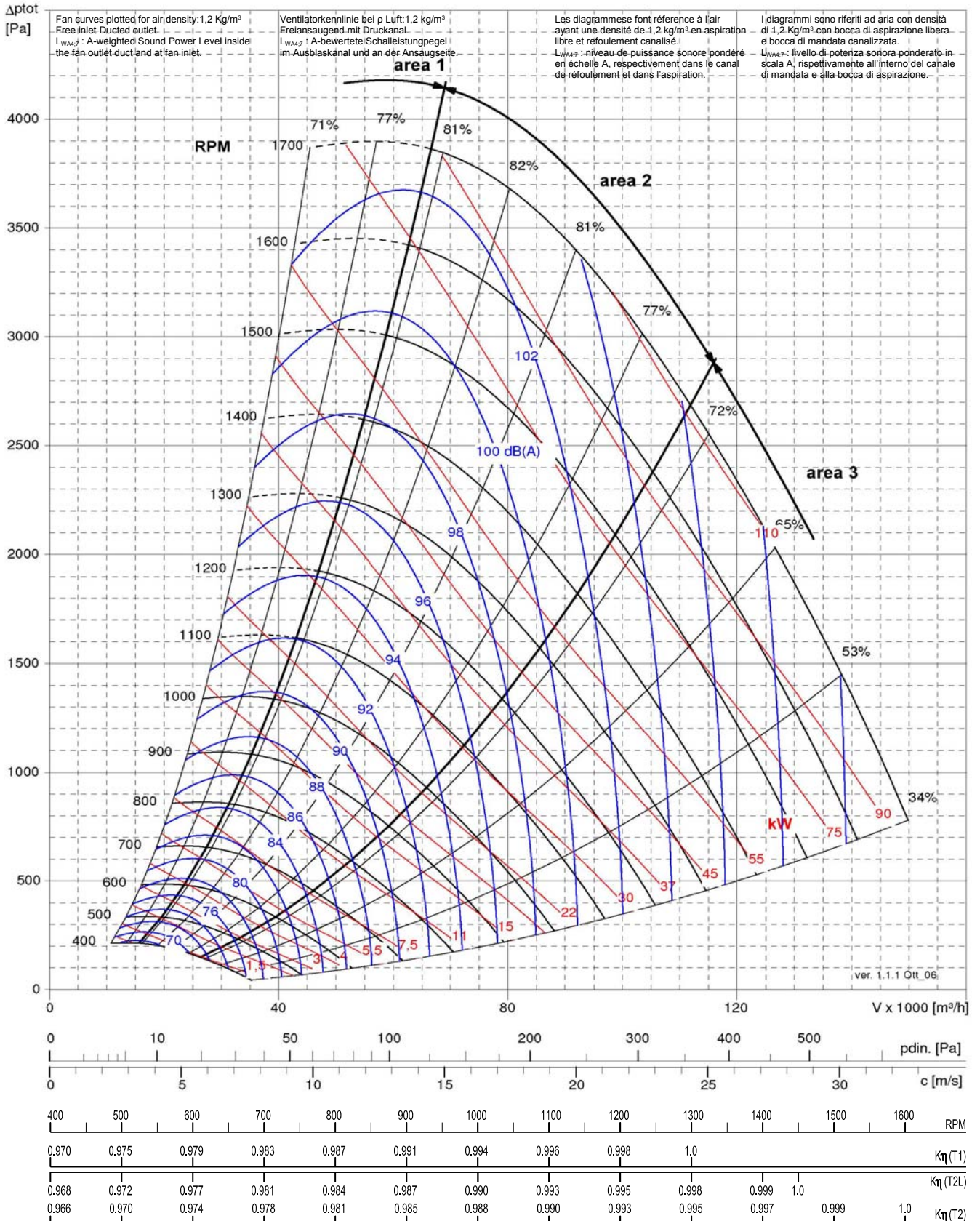



MAZ 1000		T1	T2L	T2
Fan Max RPM / Max zul. Ventilator-drehzahl / Vitesse de rotation maximale / Massima velocità di rotazione	[min ⁻¹]	1050	1250	1400
Fan Max power / Max zul. Ventilatorwellenleistung / Puissance absorbée maximale / Potenza massima assorbita	[kW]	35	47	75
Wheel diameter / Laufraddurchmesser / Diamètre nominale de la turbine / Diametro nominale della girante	[mm]	1016		
Wheel No. Blades / Schaufelanzahl / Nombre d'aubes / N° di pale	z	10		
Wheel Moment of Inertia / Laufrad Massenträgheitsmoment / Moment d'inertie de la turbine / Momento d'inertzia della girante	[kg m ²]	25	26	26
Wheel weight / Laufradgewicht / Poids de la turbine / Peso della girante	[kg]	149	156	156

Δptot [Pa]

Fan curves plotted for air density: 1.2 Kg/m³
Free inlet-Ducted outlet.
L_{WAQ7}: A-weighted Sound Power Level inside the fan outlet duct and at fan inlet.

Ventilator-kennlinie bei ρ Luft: 1.2 kg/m³
Freiansaugend mit Druckkanal.
L_{WAQ7}: A-bewertete Schalleistungspegel im Ausblaskanal und an der Ansaugseite.

Les diagrammes font référence à l'air ayant une densité de 1,2 kg/m³ en aspiration libre et refoulement canalisé.
L_{WAQ7}: niveau de puissance sonore pondéré en échelle A, respectivement dans le canal de refoulement et dans l'aspiration.

I diagrammi sono riferiti ad aria con densità di 1,2 Kg/m³ con bocca di aspirazione libera e bocca di mandata canalizzata.
L_{WAQ7}: livello di potenza sonora ponderato in scala A, rispettivamente all'interno del canale di mandata e alla bocca di aspirazione.

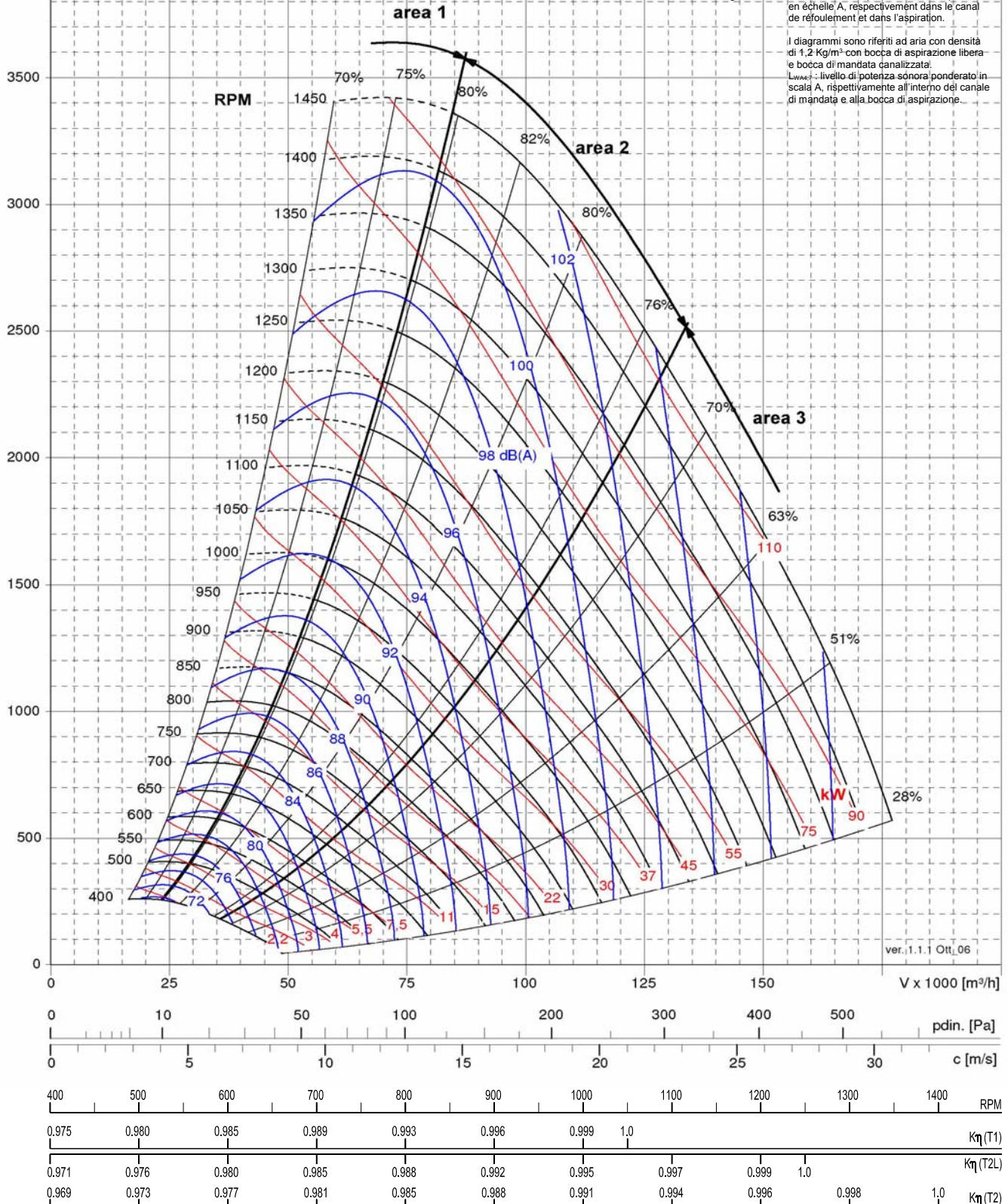



MAZ 1120		T1	T2
Fan Max RPM / Max zul. Ventilator-drehzahl / Vitesse de rotation maximale / Massa velocità di rotazione	[min ⁻¹]	850	1200
Fan Max power / Max zul. Ventilatorwellenleistung / Puissance absorbée maximale / Potenza massima assorbita	[kW]	35	100
Wheel diameter / Laufraddurchmesser / Diamètre nominale de la turbine / Diametro nominale della girante	[mm]	1136	
Wheel No. Blades / Schaufelanzahl / Nombre d'aubes / N° di pale	z	10	
Wheel Moment of Inertia / Laufrad Massenträgheitsmoment / Moment d'inertie de la turbine / Momento d'inerzia della girante	[kg m ²]	41,2	43,8
Wheel weight / Laufradgewicht / Poids de la turbine / Peso della girante	[kg]	198	208

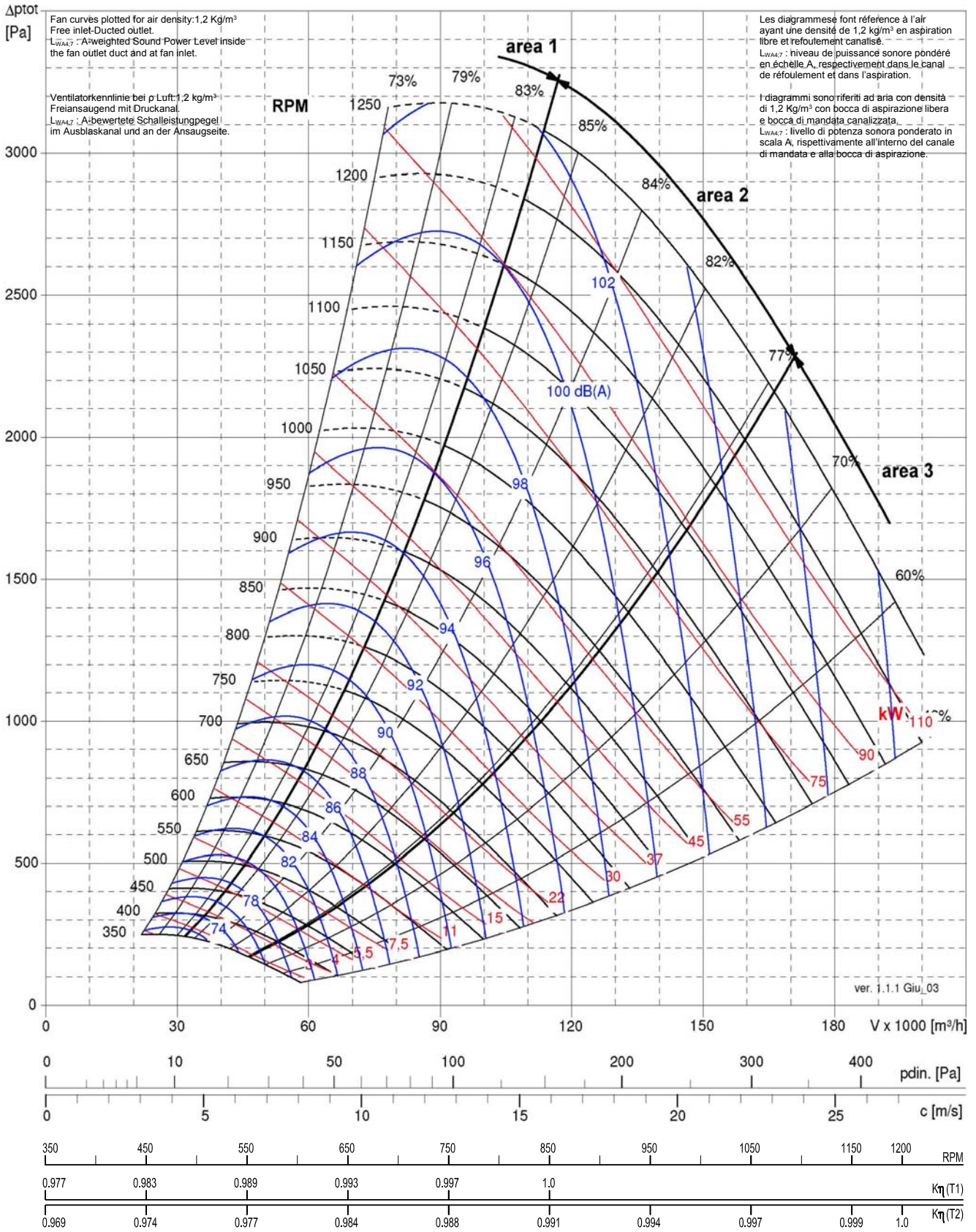



MAZ 1250		T1	T2
Fan Max RPM / Max zul. Ventilator Drehzahl / Vitesse de rotation maximale / Massa velocità di rotazione	[min ⁻¹]	800	1100
Fan Max power / Max zul. Ventilatorwellenleistung / Puissance absorbée maximale / Potenza massima assorbita	[kW]	50	130
Wheel diameter / Laufraddurchmesser / Diamètre nominale de la turbine / Diametro nominale della girante	[mm]	1266	
Wheel No. Blades / Schaufelanzahl / Nombre d'aubes / N° di pale	z	10	
Wheel Moment of Inertia / Laufrad Massenträgheitsmoment / Moment d'inertie de la turbine / Momento d'inerzia della girante	[kg m ²]	62	64
Wheel weight / Laufradgewicht / Poids de la turbine / Peso della girante	[kg]	252	258

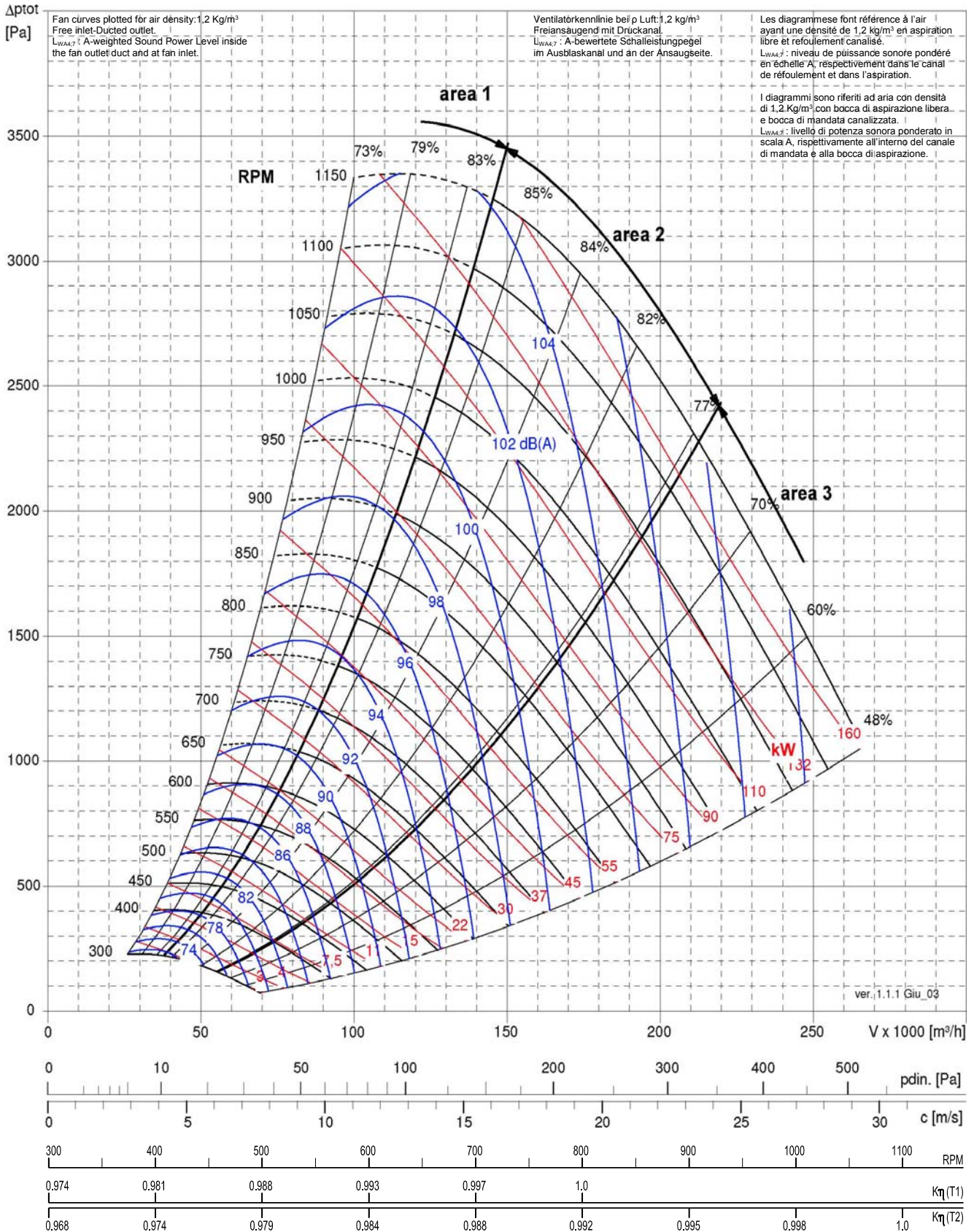

4. MHZ Performance charts

4. Curve caratteristiche della serie MHZ



MHZ 315		T1	T2
Fan Max RPM / Max zul. Ventilator Drehzahl / Vitesse de rotation maximale / Massa velocità di rotazione	[min ⁻¹]	3700	3900
Fan Max power / Max zul. Ventilatorwellenleistung / Puissance absorbée maximale / Potenza massima assorbita	[kW]	7,5	9
Wheel diameter / Laufraddurchmesser / Diamètre nominale de la turbine / Diametro nominale della girante	[mm]	325	
Wheel No. Blades / Schaufelanzahl / Nombre d'aubes / N° di pale	z	11	
Wheel Moment of Inertia / Laufrad Massenträgheitsmoment / Moment d'inertie de la turbine / Momento d'inerzia della girante	[kg m ²]	0,11	0,15
Wheel weight / Laufradgewicht / Poids de la turbine / Peso della girante	[kg]	6,9	7,2

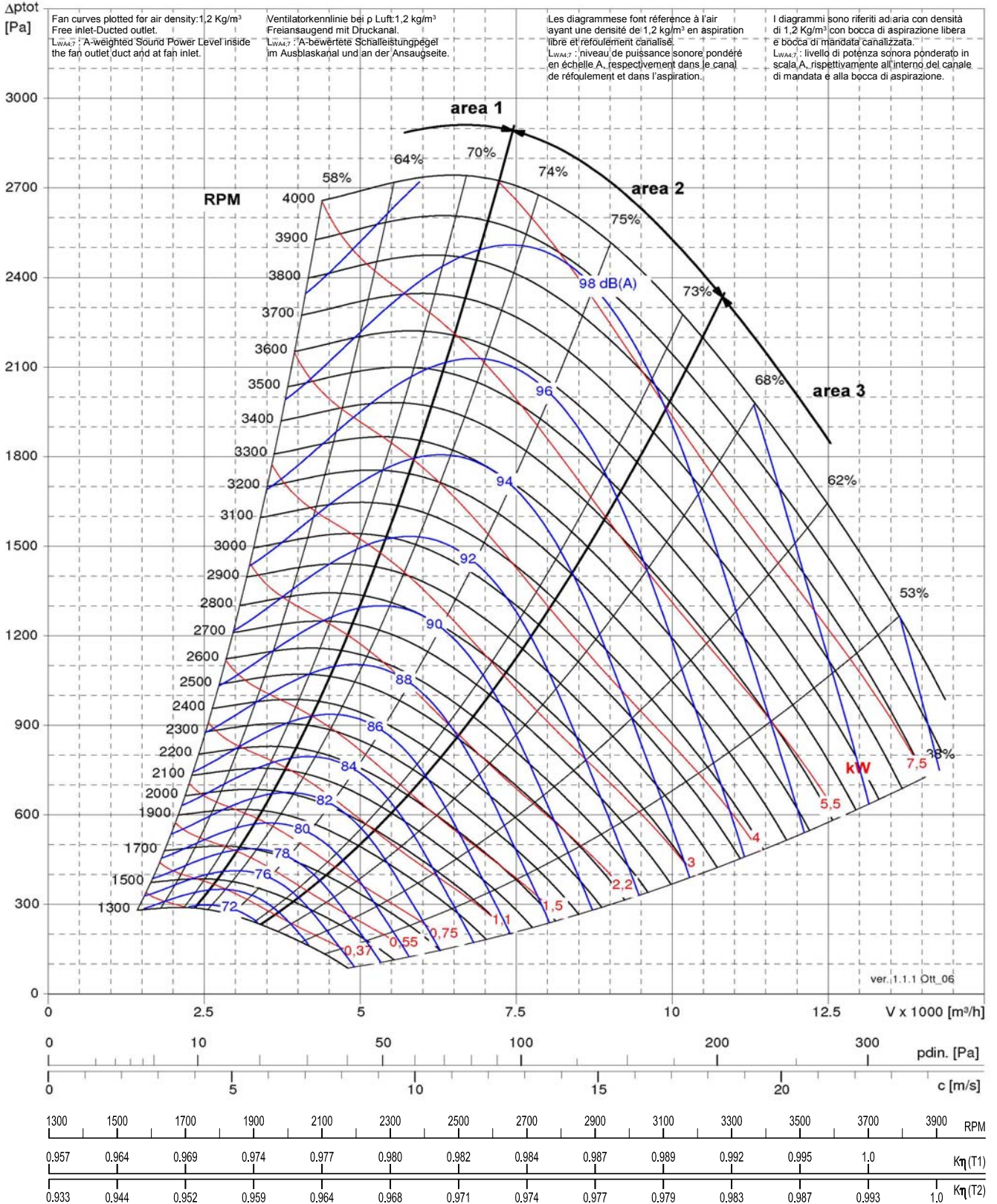



MHZ 355		T1	T2
Fan Max RPM / Max zul. Ventilatorumdrehzahl / Vitesse de rotation maximale / Massa velocità di rotazione	[min ⁻¹]	3400	3850
Fan Max power / Max zul. Ventilatorwellenleistung / Puissance absorbée maximale / Potenza massima assorbita	[kW]	9	12
Wheel diameter / Laufraddurchmesser / Diamètre nominale de la turbine / Diametro nominale della girante	[mm]	365	
Wheel No. Blades / Schaufelanzahl / Nombre d'aubes / N° di pale	z	11	
Wheel Moment of Inertia / Laufrad Massenträgheitsmoment / Moment d'inertie de la turbine / Momento d'inerzia della girante	[kg m ²]	0,18	0,24
Wheel weight / Laufradgewicht / Poids de la turbine / Peso della girante	[kg]	8,5	11,3

Δp_{tot}
[Pa]

Fan curves plotted for air density: 1.2 Kg/m³
Free inlet-Ducted outlet.
L_{WA(1,7)}: A-weighted Sound Power Level inside
the fan outlet duct and at fan inlet.

Ventilator Kennlinie bei ρ Luft: 1.2 kg/m³
Freiansaugend mit Druckkanal.
L_{WA(1,7)}: A-bewertete Schalleistungsebene
im Ausblaskanal und an der Ansaugseite.

Les diagrammes font référence à l'air
ayant une densité de 1.2 kg/m³ en aspiration
libre et refoulement canalisé.
L_{WA(1,7)}: niveau de puissance sonore pondéré
en échelle A, respectivement dans le canal
de refoulement et dans l'aspiration.

I diagrammi sono riferiti ad aria con densità
di 1.2 Kg/m³ con bocca di aspirazione libera
e bocca di mandata canalizzata.
L_{WA(1,7)}: livello di potenza sonora ponderato in
scala A, rispettivamente all'interno del canale
di mandata e alla bocca di aspirazione.

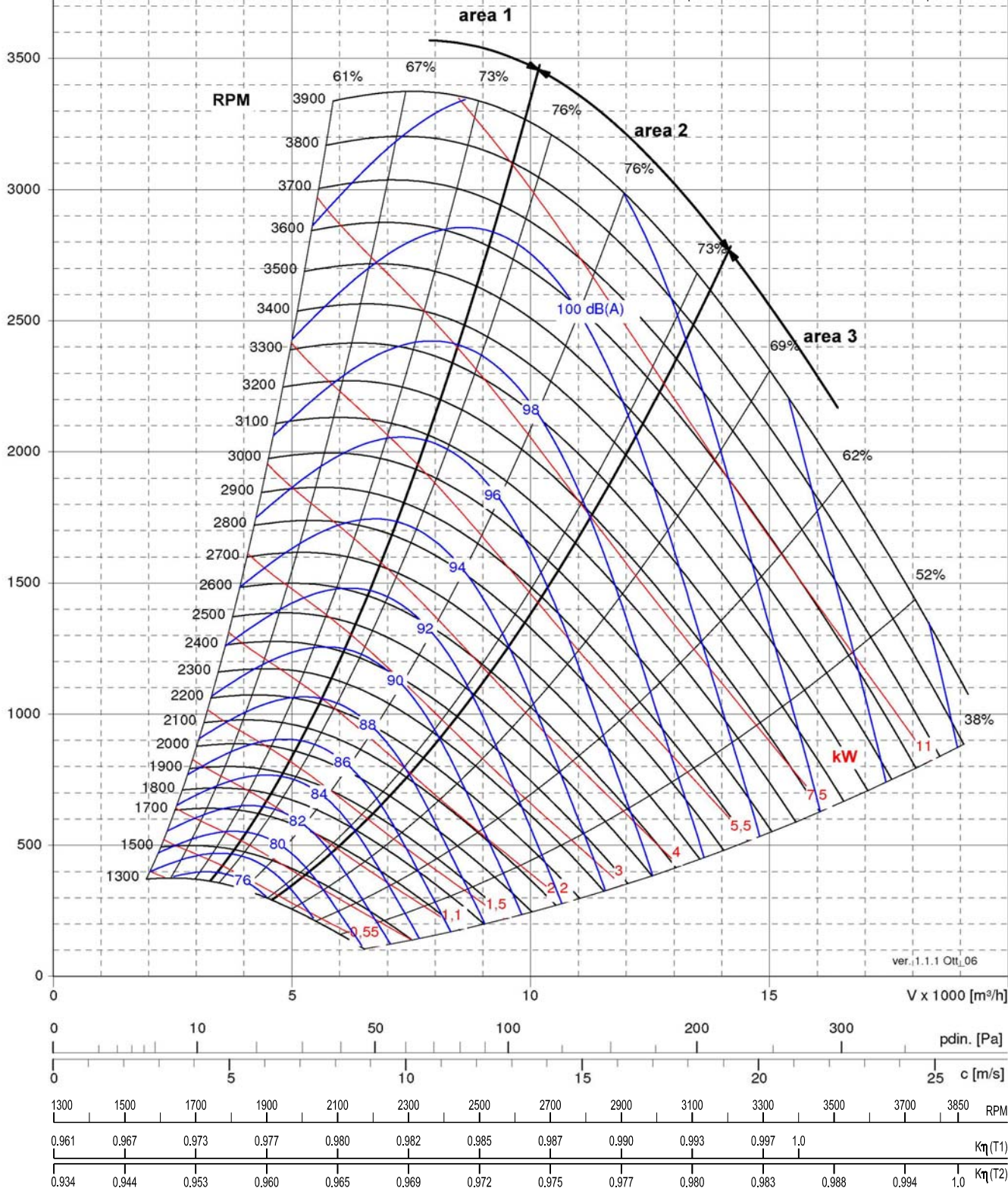



MHZ 400		T1	T2L	T2
Fan Max RPM / Max zul. Ventilator-drehzahl / Vitesse de rotation maximale / Massima velocità di rotazione	[min ⁻¹]	2950	3200	3600
Fan Max power / Max zul. Ventilatorwellenleistung / Puissance absorbée maximale / Potenza massima assorbita	[kW]	9	11	14
Wheel diameter / Laufraddurchmesser / Diamètre nominale de la turbine / Diametro nominale della girante	[mm]	412		
Wheel No. Blades / Schaufelanzahl / Nombre d'aubes / N° di pale	z	11		
Wheel Moment of Inertia / Laufrad Massenträgheitsmoment / Moment d'inertie de la turbine / Momento d'inertzia della girante	[kg m ²]	0,38	0,53	0,53
Wheel weight / Laufradgewicht / Poids de la turbine / Peso della girante	[kg]	13,5	18,5	18,5

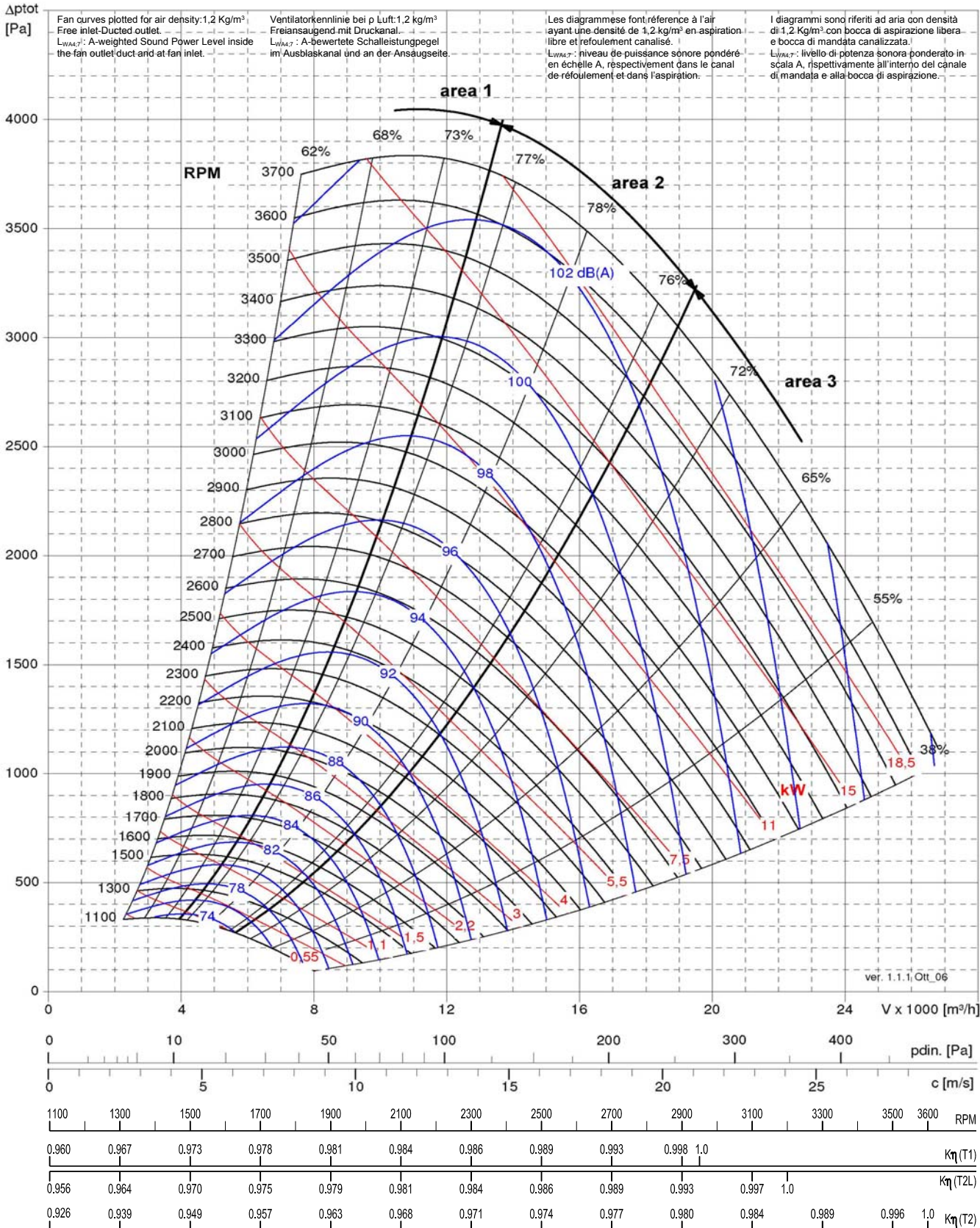



MHZ 450		T1	T2L	T2
Fan Max RPM / Max zul. Ventilator-drehzahl / Vitesse de rotation maximale / Massima velocità di rotazione	[min ⁻¹]	2650	2950	3230
Fan Max power / Max zul. Ventilatorwellenleistung / Puissance absorbée maximale / Potenza massima assorbita	[kW]	13	16	18,5
Wheel diameter / Laufraddurchmesser / Diamètre nominale de la turbine / Diametro nominale della girante	[mm]	462		
Wheel No. Blades / Schaufelanzahl / Nombre d'aubes / N° di pale	z	11		
Wheel Moment of Inertia / Laufrad Massenträgheitsmoment / Moment d'inertie de la turbine / Momento d'inertzia della girante	[kg m ²]	0,59	0,83	0,83
Wheel weight / Laufradgewicht / Poids de la turbine / Peso della girante	[kg]	16,7	23,3	23,3

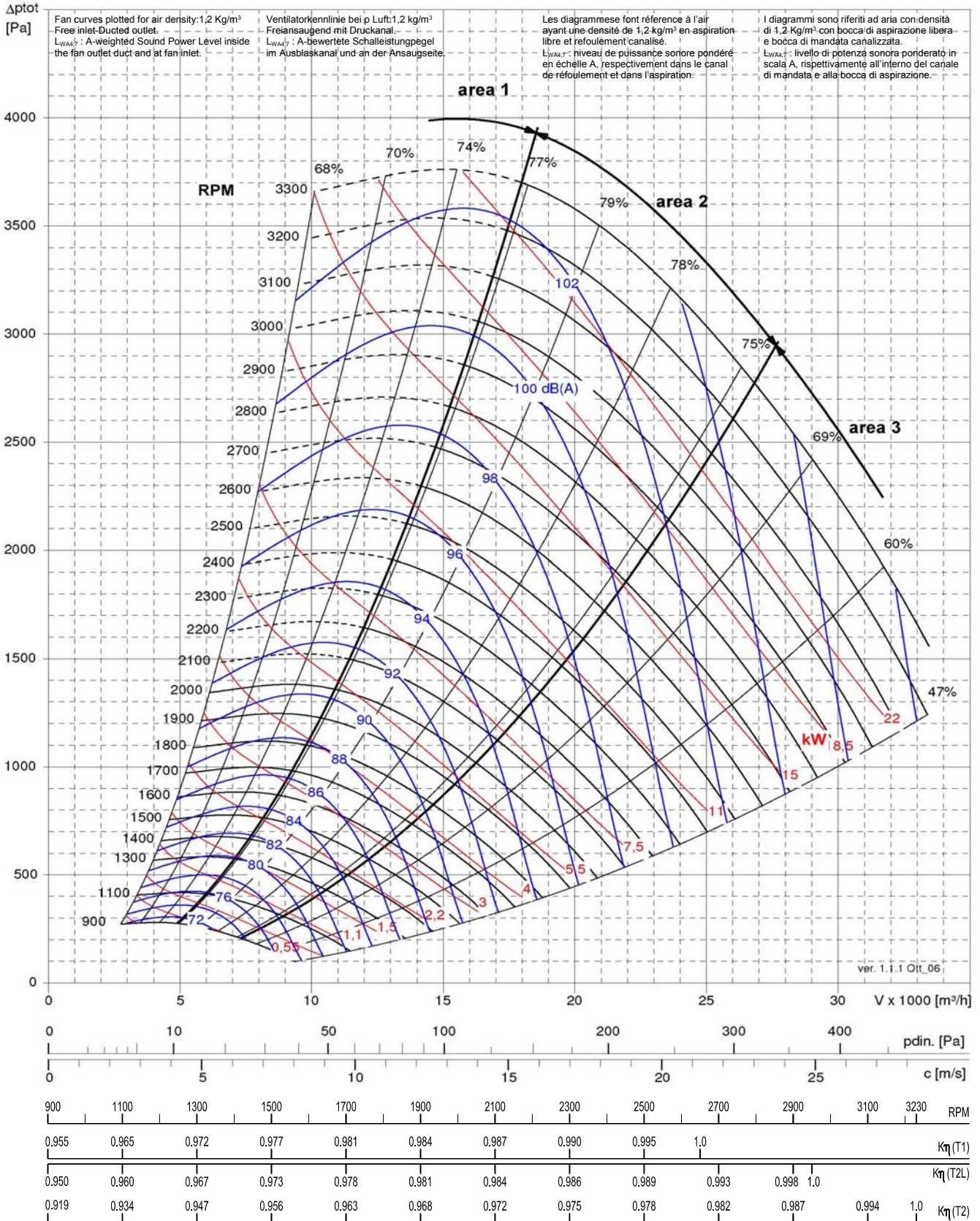



MHZ 500		T1	T2L	T2
Fan Max RPM / Max zul. Ventilator Drehzahl / Vitesse de rotation maximale / Massima velocità di rotazione	[min ⁻¹]	2200	2500	2720
Fan Max power / Max zul. Ventilatorwellenleistung / Puissance absorbée maximale / Potenza massima assorbita	[kW]	13	16	21
Wheel diameter / Laufraddurchmesser / Diamètre nominale de la turbine / Diametro nominale della girante	[mm]	513		
Wheel No. Blades / Schaufelanzahl / Nombre d'aubes / N° di pale	z	11		
Wheel Moment of Inertia / Laufrad Massenträgheitsmoment / Moment d'inertie de la turbine / Momento d'inertzia della girante	[kg m ²]	0,90	1,23	1,23
Wheel weight / Laufradgewicht / Poids de la turbine / Peso della girante	[kg]	20,6	27,9	27,9

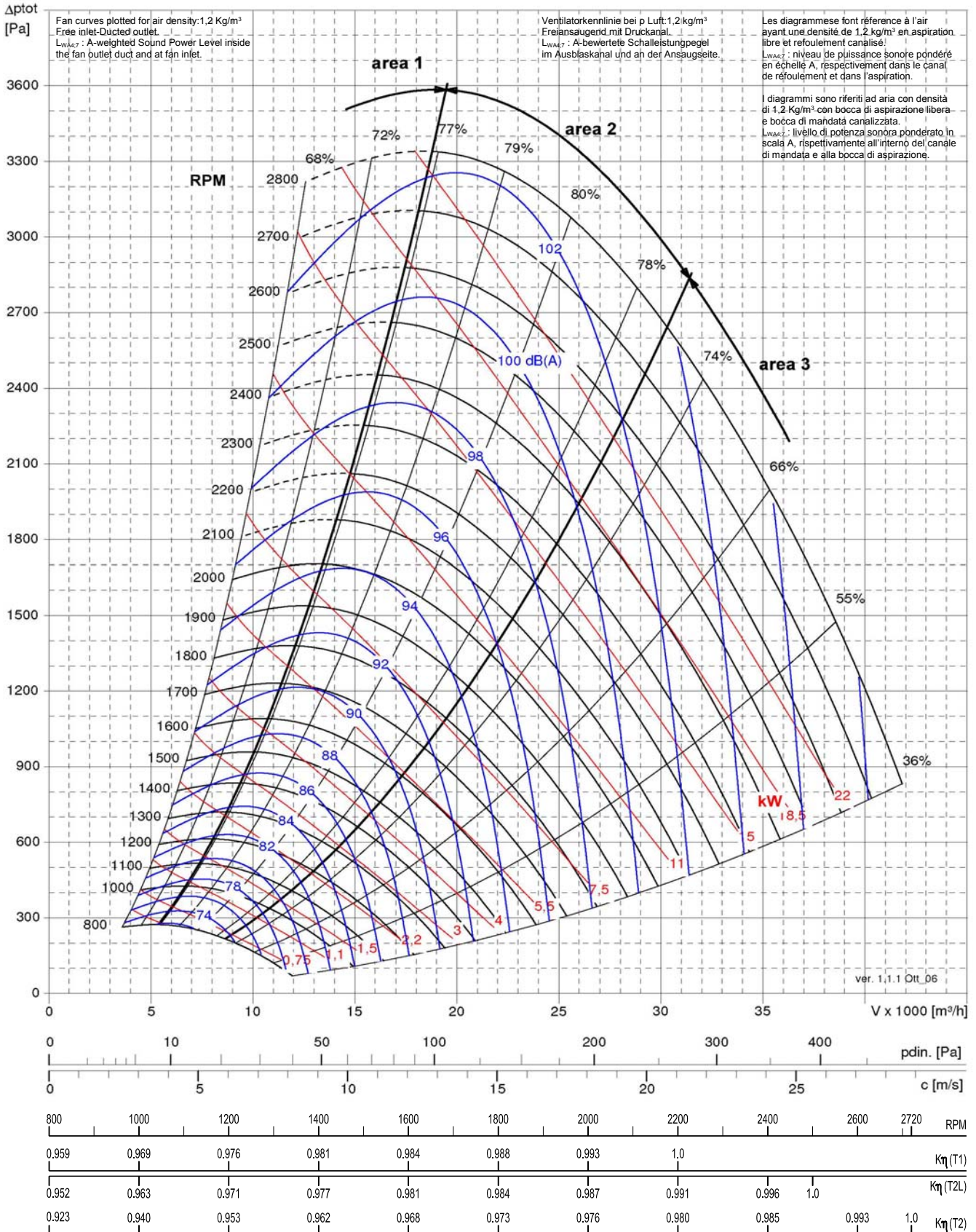



MHZ 560		T1	T2L	T2
Fan Max RPM / Max zul. Ventilator Drehzahl / Vitesse de rotation maximale / Massima velocità di rotazione	[min ⁻¹]	2050	2400	2600
Fan Max power / Max zul. Ventilatorwellenleistung / Puissance absorbée maximale / Potenza massima assorbita	[kW]	18,5	28	35
Wheel diameter / Laufraddurchmesser / Diamètre nominale de la turbine / Diametro nominale della girante	[mm]	575		
Wheel No. Blades / Schaufelanzahl / Nombre d'aubes / N° di pale	z	11		
Wheel Moment of Inertia / Laufrad Massenträgheitsmoment / Moment d'inertie de la turbine / Momento d'inertzia della girante	[kg m ²]	1,55	2,29	2,29
Wheel weight / Laufradgewicht / Poids de la turbine / Peso della girante	[kg]	23,4	41,4	41,4

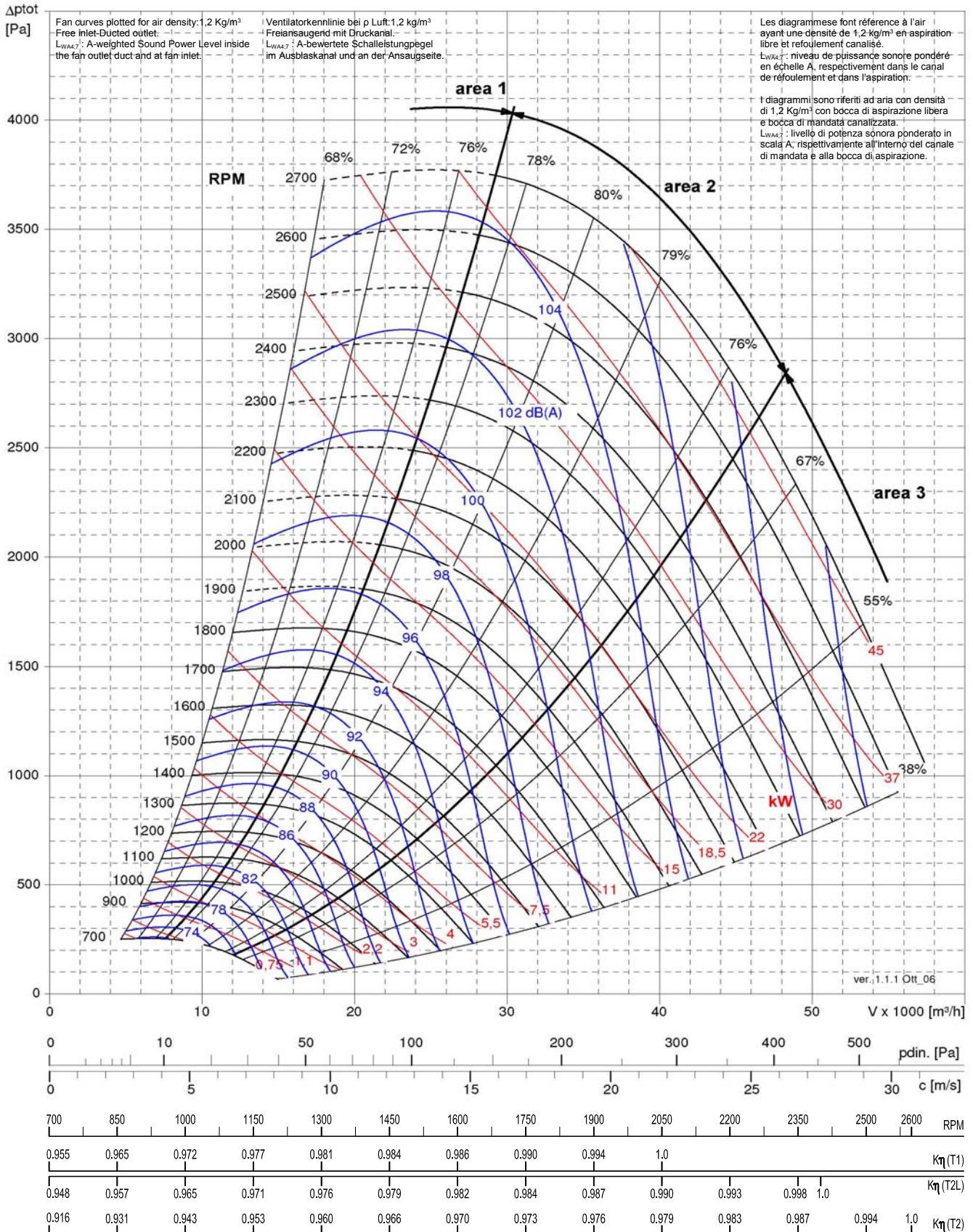



MHZ 630		T1	T2L	T2
Fan Max RPM / Max zul. Ventilator Drehzahl / Vitesse de rotation maximale / Massima velocità di rotazione	[min ⁻¹]	1650	2100	2275
Fan Max power / Max zul. Ventilatorwellenleistung / Puissance absorbée maximale / Potenza massima assorbita	[kW]	18,5	28	40
Wheel diameter / Laufraddurchmesser / Diamètre nominale de la turbine / Diametro nominale della girante	[mm]	646		
Wheel No. Blades / Schaufelanzahl / Nombre d'aubes / N° di pale	z	11		
Wheel Moment of Inertia / Laufrad Massenträgheitsmoment / Moment d'inertie de la turbine / Momento d'inerzia della girante	[kg m ²]	2,56	3,61	3,61
Wheel weight / Laufradgewicht / Poids de la turbine / Peso della girante	[kg]	37	51,8	51,8

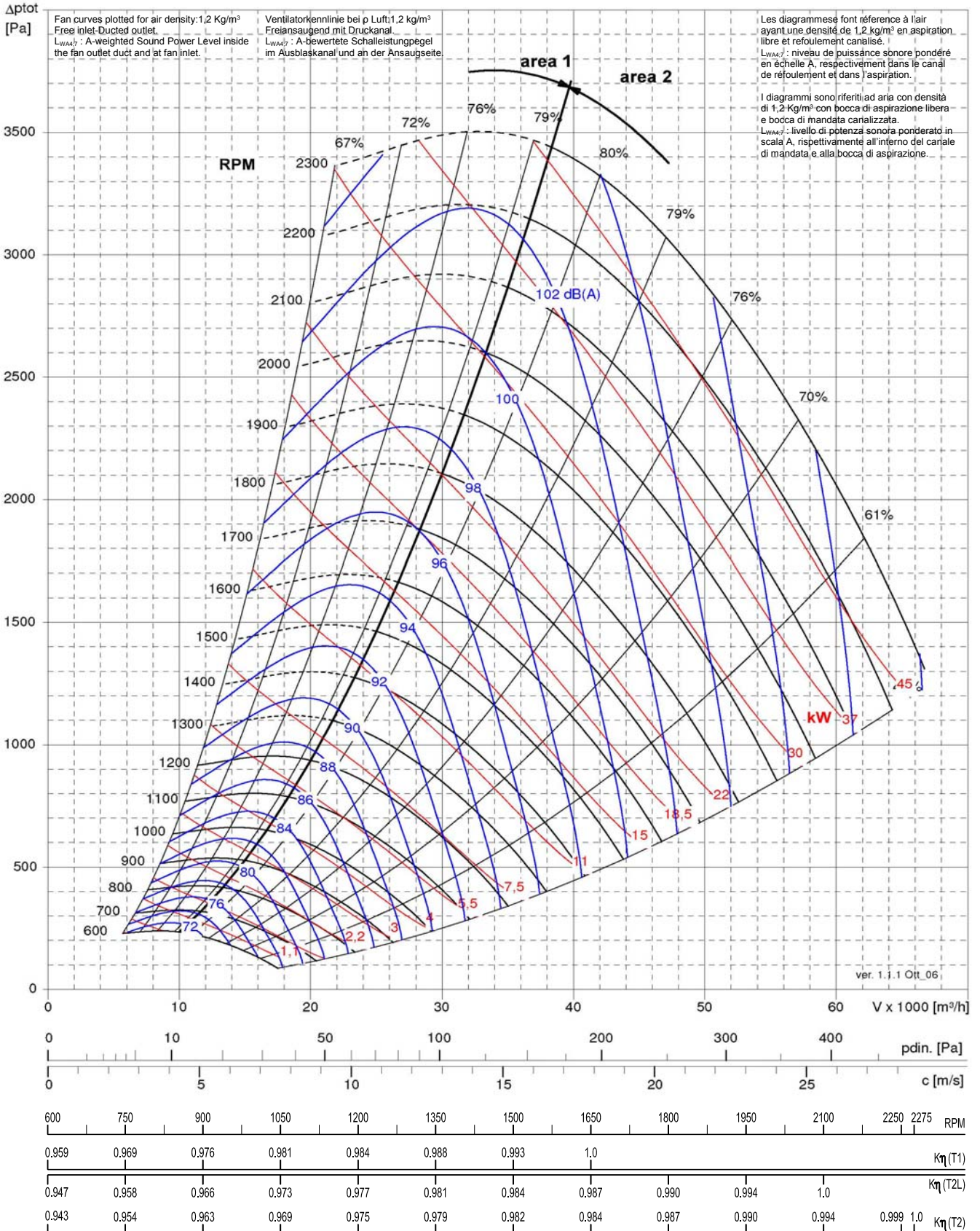



MHZ 710		T1	T2L	T2
Fan Max RPM / Max zul. Ventilator Drehzahl / Vitesse de rotation maximale / Massima velocità di rotazione	[min ⁻¹]	1500	1850	2015
Fan Max power / Max zul. Ventilatorwellenleistung / Puissance absorbée maximale / Potenza massima assorbita	[kW]	22	35	45
Wheel diameter / Laufraddurchmesser / Diamètre nominale de la turbine / Diametro nominale della girante	[mm]	722		
Wheel No. Blades / Schaufelanzahl / Nombre d'aubes / N° di pale	z	11		
Wheel Moment of Inertia / Laufrad Massenträgheitsmoment / Moment d'inertie de la turbine / Momento d'inertzia della girante	[kg m ²]	4,61	6,37	6,37
Wheel weight / Laufradgewicht / Poids de la turbine / Peso della girante	[kg]	53	73,2	73,2

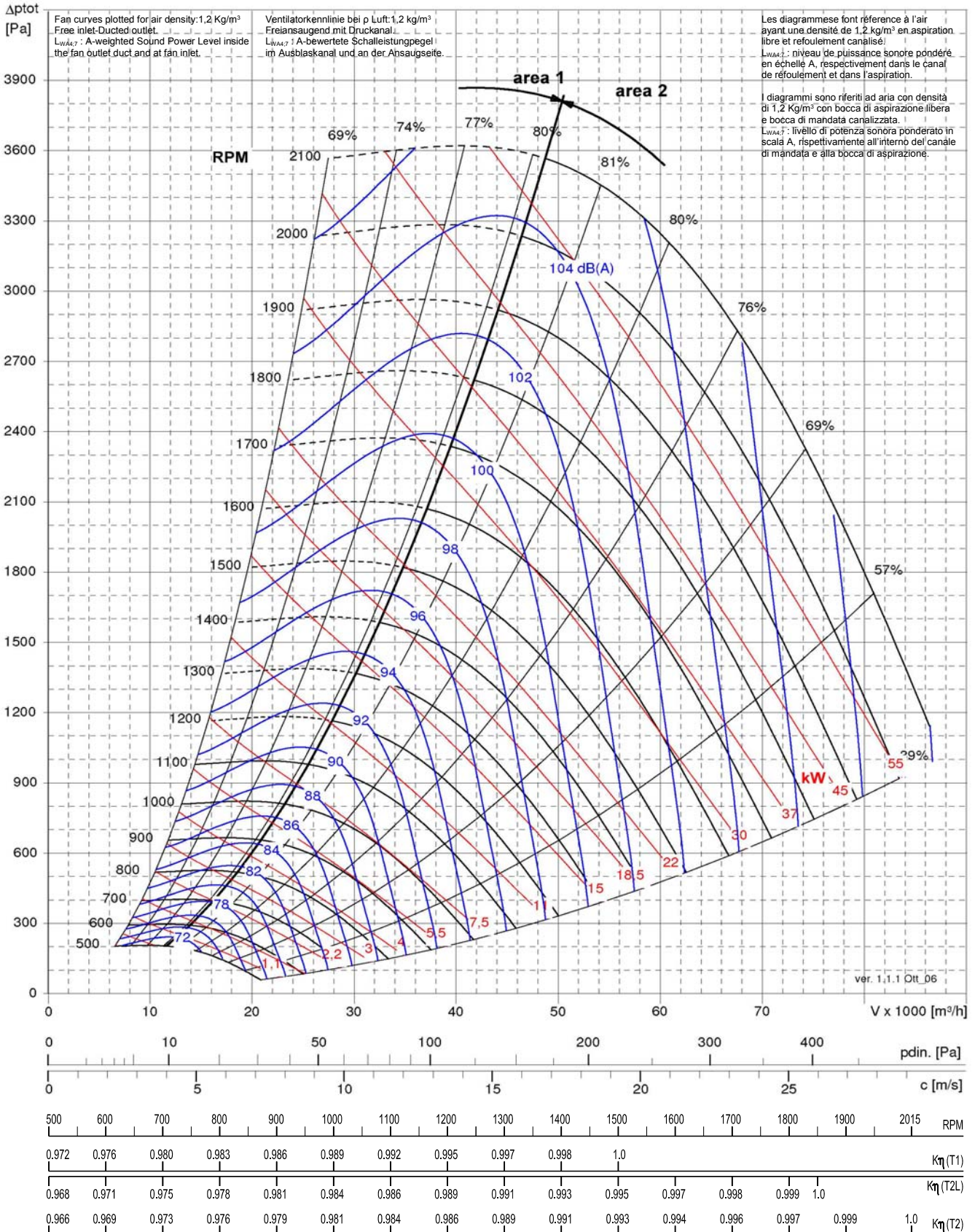



MHZ 800		T1	T2L	T2
Fan Max RPM / Max zul. Ventilator Drehzahl / Vitesse de rotation maximale / Massima velocità di rotazione	[min ⁻¹]	1200	1500	1700
Fan Max power / Max zul. Ventilatorwellenleistung / Puissance absorbée maximale / Potenza massima assorbita	[kW]	22	35	50
Wheel diameter / Laufraddurchmesser / Diamètre nominale de la turbine / Diametro nominale della girante	[mm]	813		
Wheel No. Blades / Schaufelanzahl / Nombre d'aubes / N° di pale	z	11		
Wheel Moment of Inertia / Laufrad Massenträgheitsmoment / Moment d'inertie de la turbine / Momento d'inertzia della girante	[kg m ²]	7,72	10,53	10,53
Wheel weight / Laufradgewicht / Poids de la turbine / Peso della girante	[kg]	70,2	95,6	95,6

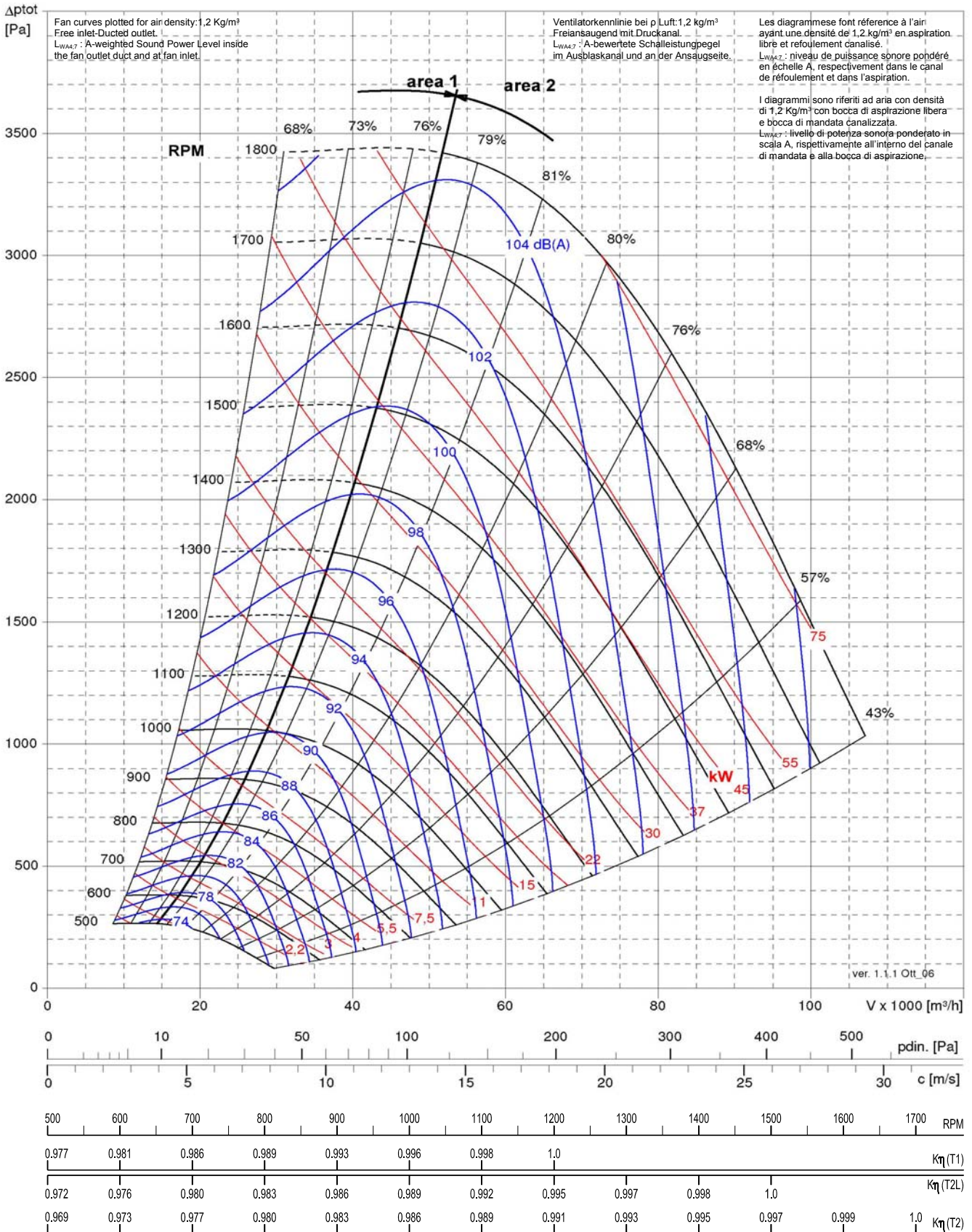



MHZ 900		T1	T2L	T2
Fan Max RPM / Max zul. Ventilatorordrehzahl / Vitesse de rotation maximale / Massima velocità di rotazione	[min ⁻¹]	1200	1350	1500
Fan Max power / Max zul. Ventilatorwellenleistung / Puissance absorbée maximale / Potenza massima assorbita	[kW]	33	45	70
Wheel diameter / Laufraddurchmesser / Diamètre nominale de la turbine / Diametro nominale della girante	[mm]	913		
Wheel No. Blades / Schaufelanzahl / Nombre d'aubes / N° di pale	z	11		
Wheel Moment of Inertia / Laufrad Massenträgheitsmoment / Moment d'inertie de la turbine / Momento d'inertzia della girante	[kg m ²]	14,48	17,59	17,59
Wheel weight / Laufradgewicht / Poids de la turbine / Peso della girante	[kg]	103	126,5	126,5

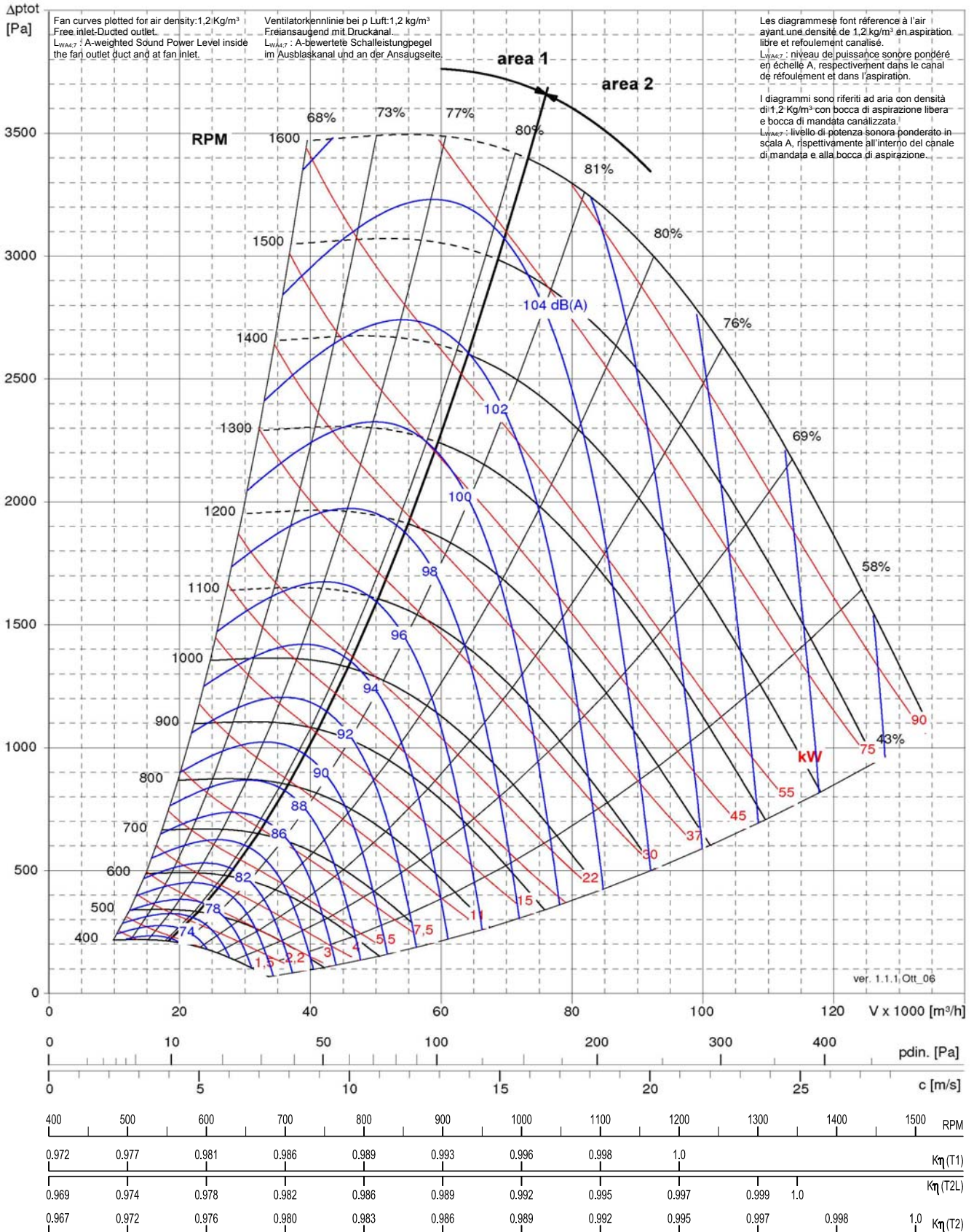



MHZ 1000		T1	T2L	T2
Fan Max RPM / Max zul. Ventilatorordrehzahl / Vitesse de rotation maximale / Massima velocità di rotazione	[min ⁻¹]	1050	1150	1260
Fan Max power / Max zul. Ventilatorwellenleistung / Puissance absorbée maximale / Potenza massima assorbita	[kW]	35	45	75
Wheel diameter / Laufraddurchmesser / Diamètre nominale de la turbine / Diametro nominale della girante	[mm]	1016		
Wheel No. Blades / Schaufelanzahl / Nombre d'aubes / N° di pale	z	11		
Wheel Moment of Inertia / Laufrad Massenträgheitsmoment / Moment d'inertie de la turbine / Momento d'inertzia della girante	[kg m ²]	20,89	28,24	28,24
Wheel weight / Laufradgewicht / Poids de la turbine / Peso della girante	[kg]	124	168	168

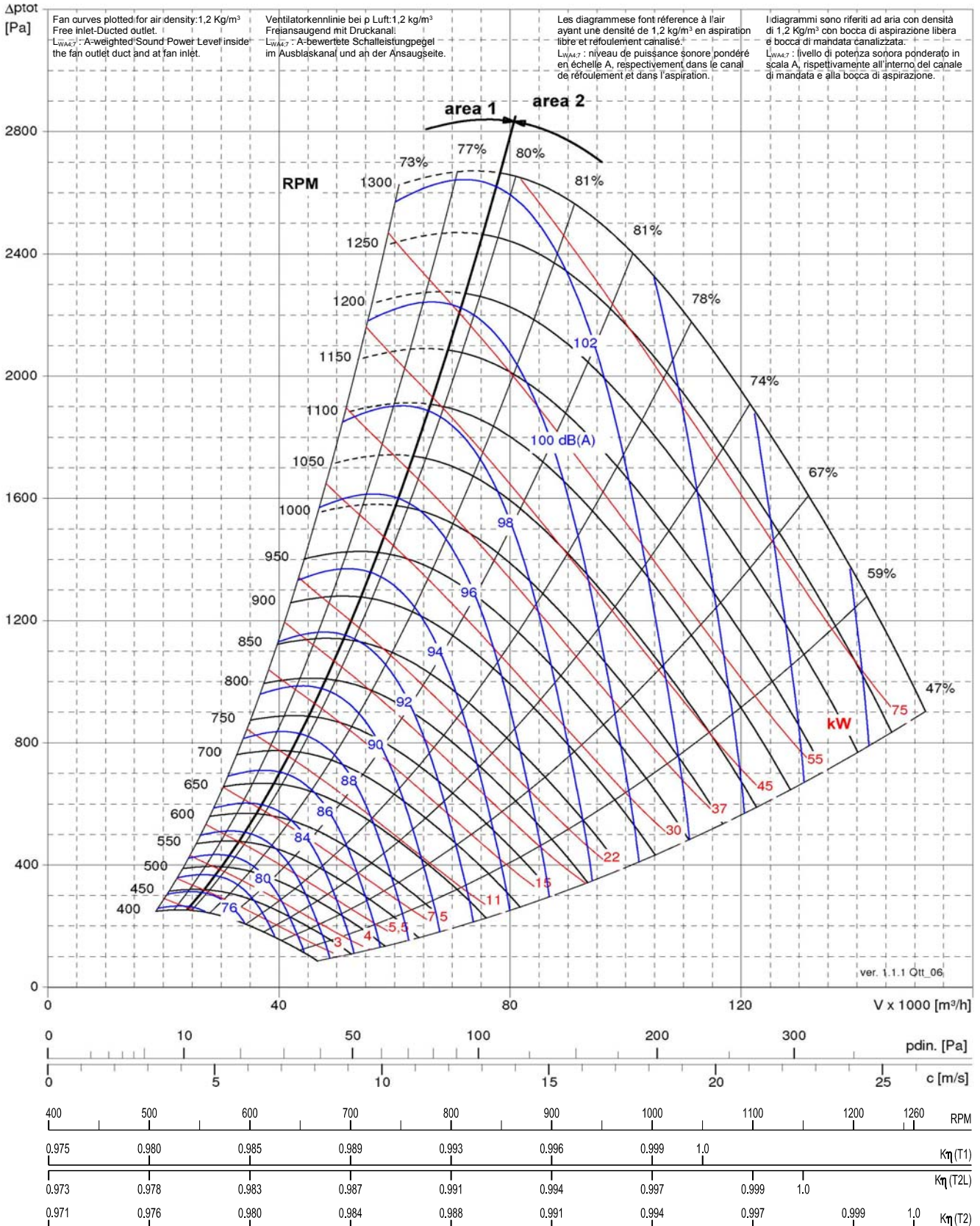



MHZ 1120		T1	T2
Fan Max RPM / Max zul. Ventilator Drehzahl / Vitesse de rotation maximale / Massa velocità di rotazione	[min ⁻¹]	825	1175
Fan Max power / Max zul. Ventilatorwellenleistung / Puissance absorbée maximale / Potenza massima assorbita	[kW]	35	100
Wheel diameter / Laufraddurchmesser / Diamètre nominale de la turbine / Diametro nominale della girante	[mm]	1136	
Wheel No. Blades / Schaufelanzahl / Nombre d'aubes / N° di pale	z	11	
Wheel Moment of Inertia / Laufrad Massenträgheitsmoment / Moment d'inertie de la turbine / Momento d'inerzia della girante	[kg m ²]	38,43	57,67
Wheel weight / Laufradgewicht / Poids de la turbine / Peso della girante	[kg]	219	337

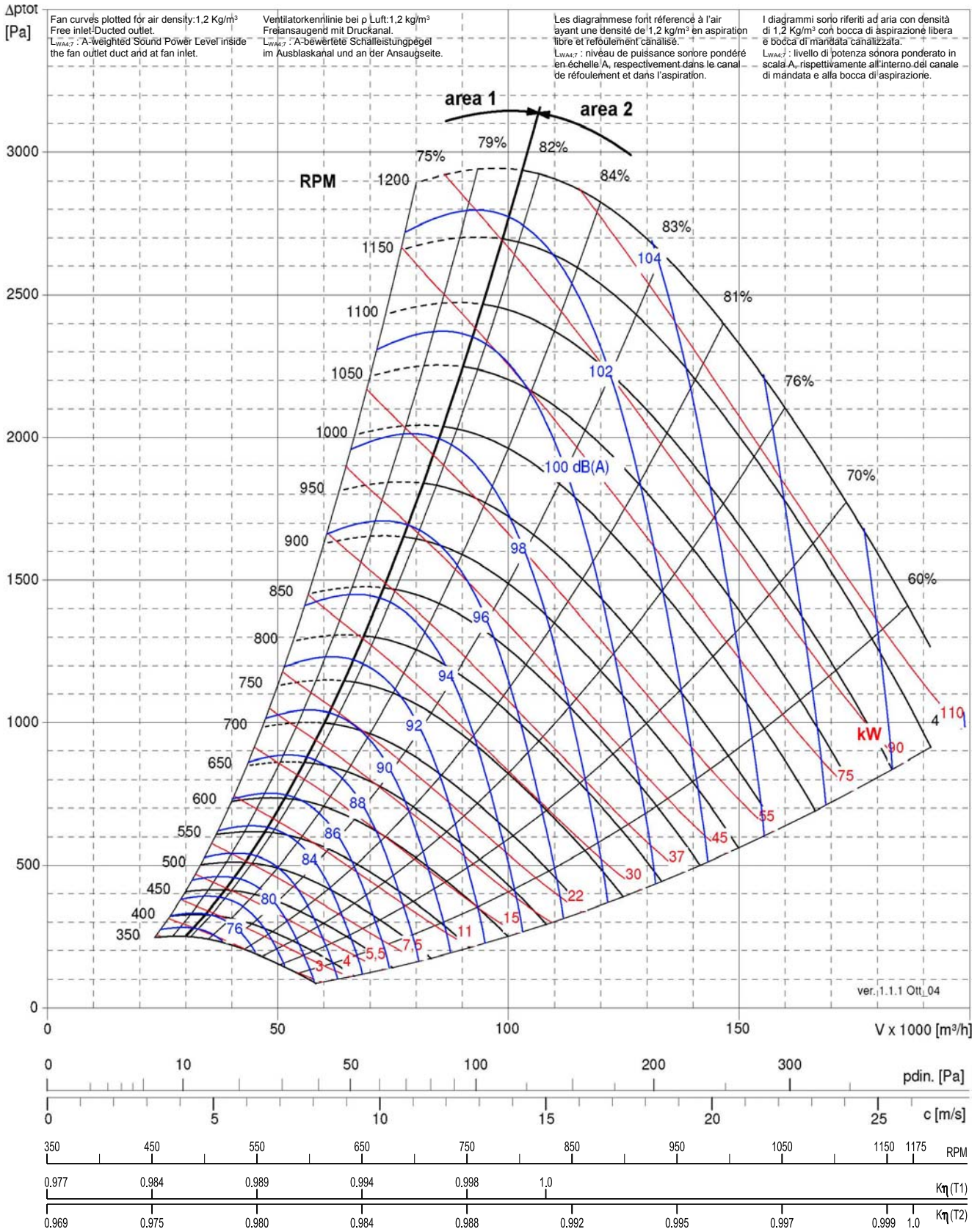



MHZ 1250		T1	T2
Fan Max RPM / Max zul. Ventilator-drehzahl / Vitesse de rotation maximale / Massa velocità di rotazione	[min ⁻¹]	765	1050
Fan Max power / Max zul. Ventilatorwellenleistung / Puissance absorbée maximale / Potenza massima assorbita	[kW]	50	130
Wheel diameter / Laufraddurchmesser / Diamètre nominale de la turbine / Diametro nominale della girante	[mm]	1266	
Wheel No. Blades / Schaufelanzahl / Nombre d'aubes / N° di pale	z	11	
Wheel Moment of Inertia / Laufrad Massenträgheitsmoment / Moment d'inertie de la turbine / Momento d'inerzia della girante	[kg m ²]	64,72	86,14
Wheel weight / Laufradgewicht / Poids de la turbine / Peso della girante	[kg]	292	383

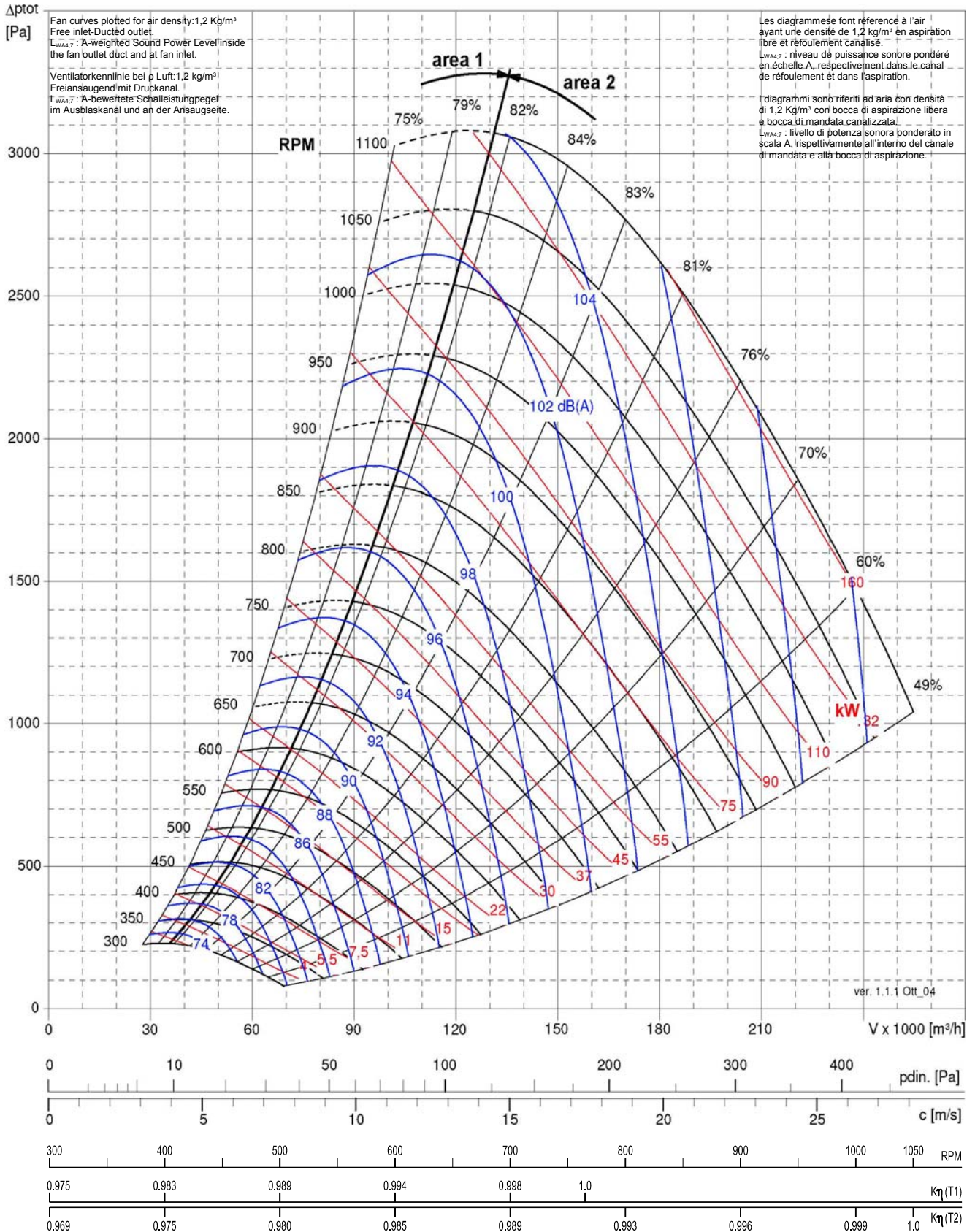

5. Fan dimensions

MAZ / MHZ 315 ÷ 1250 T1 / T2L / T2

5. Dimensioni dei ventilatori

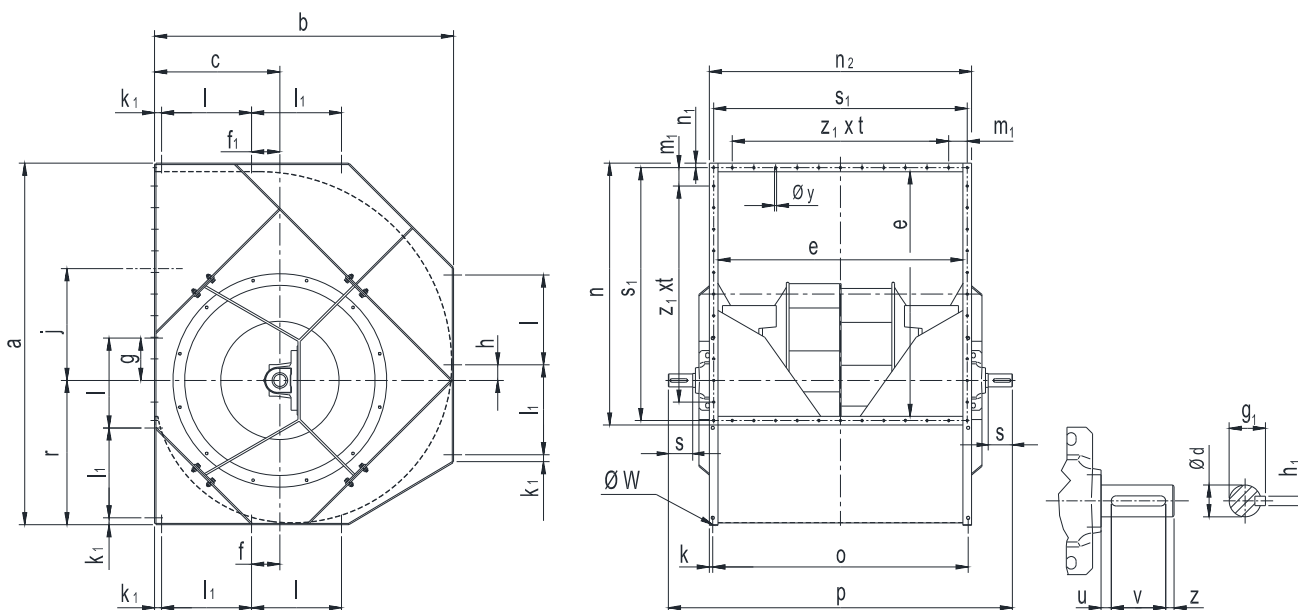

Grandezza	a	b	c	Ød			e	f	f ₁	g	h	k	k ₁	g ₁			h ₁			j	l	l ₁	m ₁	n
				T1	T2L	T2								T1	T2L	T2	T1	T2L	T2					
315	602	522	236	25	-	25	402	79	79	58	3	15	23	28	-	28	8	-	8	140	135	135	37	455
355	676	581	261	30	-	35	450	74	94	67	16	19	23	33	-	38	8	-	10	158	145	165	61,5	504
400	762	651	290	30	35	35	505	128	53	78	27	19	23	33	38	8	10	10	179	215	140	43,5	565	
450	852	726	322	35	40	40	568	122	72	89	10	20	25	38	43	10	12	12	202	225	175	29,5	628	
500	943	800	352	35	40	40	635	102	102	101	19	19	25	38	43	10	12	12	221	225	225	64	695	
560	1053	892	390	40	50	50	711	145	75	111	13	24	30	43	53,5	12	14	14	248	285	215	57,5	771	
630	1180	998	434	40	50	50	797	119	119	124	26	24	35	43	53,5	12	14	14	281	280	280	55,5	857	
710	1326	1120	485	50	60	60	894	160	100	139	0	20	40	53,5	64	14	18	18	318	345	285	59	954	
800	1489	1255	540	50	60	60	1003	140	140	158	36	18	45	53,5	64	14	18	18	360	355	355	113,5	1063	
900	1676	1409	604	60			1126	89	219	158	36	18	50	64			18			408	355	465	32	1196
1000	1837	1541	657	60			1263	157	157	215	61	18	50	64			18			436	450	450	50,5	1333
1120	2092	1727	724	70	-	75	1415	164	164	245	90	20	40	74,5	-	79,5	20	-	20	500	520	520	107,5	1515
1250	2329	1929	931	70	-	75	1586	185	185	279	93	20	40	74,5	-	79,5	20	-	20	554	585	585	73	1686

Grandezza	n ₁	n ₂	o	p			r	s			s ₁	Øy	z ₁ x t	u			v			z			ØW
				T1	T2L	T2		T1	T2L	T2				T1	T2L	T2	T1	T2L	T2	T1	T2L	T2	
315	10,5	464	434	608	-	650	235	72	-	93	434	7,5	4x90	7	-	10	40	-	40	5	-	5	9
355	10,5	532	494	709	-	730	266	889	-	99	483	7,5	4x90	22	-	7	40	-	50	10	-	10	9
400	14	587	549	753	780	780	300	83	97	97	537	9	5x90	17	23	10	40	50	10	5	9	9	
450	14,5	650	611	875	920	920	336	113	135	135	599	9	6x90	32	31	16	50	70	10	9	9	9	
500	13,5	718	681	906	955	983	374	94	119	7,5	668	9	6x90	14	15	19	50	70	10	5	9	9	
560	13	815	768	1028	1118	1118	419	107	152	152	745	9	7x90	13	33	28	70	80	10	11	11	11	
630	13	901	854	1115	1220	1220	471	107	160	160	831	9	8x90	13	41	36	70	80	10	11	11	11	
710	13	998	961	1260	1336	1336	531	131	169	169	928	9	9x90	22	39	29	80	90	10	13	13	13	
800	13	1107	1071	1367	1445	1445	597	130	169	169	1037	10,5	9x90	21	39	29	80	90	10	13	13	13	
900	16	1230	1194	1529	1574	1574	670	150	172	172	1164	10,5	11x90	25	42	32	90	10	15	15	15	15	
1000	16	1367	1331	1666	1712	1712	735	150	173	173	1301	10,5	12x100	25	42	33	90	10	15	15	15	15	
1120	25	1515	1475	1875	-	1975	835	180	-	230	1465	11,5	10x125	30	-	20	100	-	100	10	-	20	18
1250	20	1686	1646	2125	-	2125	931	220	-	220	1646	15	12x125	20	-	20	100	-	100	20	-	20	18

Comefri SpA

Via Buja, 3
I-33010 Magnano in Riviera (UD)
Italy
Tel. +39-0432-798811
Fax +39-0432-783378
www.comefri.com
E-mail: sales@comefri.com

Comefri UK Ltd

Carters Lane, 8 Kiln Farm
Milton Keynes, MK11 3 ER
Great Britain
Tel. +44-1908-56 94 69
Fax +44-1908-56 75 66
www.comefri.com
E-mail: sales@comefri.co.uk

Comefri USA, Inc

330 Bill Bryan Boulevard
Hopkinsville, KY 42240
USA
Tel. + 1-270-881-1444
Fax + 1-270-889-0309
www.comefriusa.com
E-mail: sales@comefriusa.com

Comefri Gmbh

Oskar von Miller Str.1
84051 Altheim
Germany
Tel. +49-871-43070-0
Fax +49-871-43070-40
www.comefri.de
E-mail: info@comefri.de

Comefri France S.A.

5, Rue de Lombardie
69800 St Priest
France
Tel. +33-4-72 79 03 80
Fax +33-4-78 90 69 73
www.comefri.com
E-mail: info@comefrifrance.fr

Comefri China Ind. Co. Ltd.

Suite 1201, North Tower, New
World Times Center, 2191
Guangyuan Rd. (E.) Guangzhou.
P.R.C.
Tel: +86 20 8773 1890/1891
Fax: +86 8773 1893
<http://www.comefrichina.com>
E-mail: sales@comefrichina.com

